

FABBRI[®]

PORTATUTTO



Un Italiano Vero!



GB ES IT

Edizione 2018

COMPANY WITH
QUALITY SYSTEM
CERTIFIED BY DNV GL
= ISO 9001 =



1962 - 2012



Un Italiano Vero!





Un Italiano Vero!

GB The company Fabbri, founded as manufacturer of accessories for motor vehicles, over time it specialised in the field of load carrying system or accessories assigned for the transport of things used in spare time and for work, becoming a reference point for the proposed innovative construction solutions.

ES La empresa Fabbri, nacida como empresa fabricante de accesorios para automóviles, se ha venido especializando en el sector del portaje, es decir los accesorios específicos para el transporte de objetos para el tiempo libre y para el trabajo, siendo un punto de referencia en Europa por sus soluciones de construcción innovadoras.

La gama se ha ampliado continuamente, realizando variantes a las líneas históricas de producto y proponiendo otras nuevas, como por ejemplo la gama de cajas de techo.

Desde la fundación de Fabbri Srl hasta hoy, la empresa ha contado con el apoyo de técnicos y colaboradores jóvenes y expertos, asegurando la continuidad de una línea de productos altamente cualificados. En un mercado cada vez más exigente y sometido a continuos cambios, los técnicos se enfrentan al reto de buscar soluciones adecuadas para satisfacer a la clientela más severa.

La filosofía de empresa, orgullosa de realizar productos 100% made in Italy,

IT L'azienda Fabbri, nata come ditta produttrice di accessori per autoveicoli nel tempo si è specializzata nel settore del portaggio, ovvero degli accessori adibiti al trasporto di oggetti per il tempo libero e per il lavoro diventando un punto di riferimento in Europa per le soluzioni di costruzioni innovative proposte.

La gamma è stata ampliata nel tempo, proponendo varianti alle storiche linee di prodotto e proponendone di nuove, come per esempio la gamma dei box da tetto.

The range has been enlarged over time, proposing variations to the historical product lines and proposing new ones, such as the range of roof boxes.

An increasingly demanding market and its constant changes commit engineers to search appropriate solutions to satisfy even the most demanding customer.

The production philosophy, proudly 100% made in Italy, was always based on quality and safety, which made it possible in time to become a qualified supplier for the line of accessories of different and prestigious car manufacturers. Last but not least the company has recently embraced the renewable energy policy with the installation of a photovoltaic system, showing its sensitivity towards a better environment.

se basa desde siempre en conceptos como la calidad y seguridad, que le han permitido en el tiempo convertirse en proveedor cualificado de una línea de accesorios de diversos y prestigiosos fabricantes de automóviles.

No menos importante ha sido la decisión de la empresa de unirse recientemente a la política de las energías renovables, instalando un sistema fotovoltaico y demostrando con ello su compromiso por la mejora del medio ambiente.

Dalla fondazione della Fabbri Srl ad oggi l'azienda ha assicurato continuità ad una gamma di prodotti altamente qualificati con il supporto dei propri tecnici e collaboratori giovani ed esperti.

Un mercato sempre più esigente ed i suoi continui cambiamenti impegnano i tecnici nella ricerca di soluzioni adeguate per poter accontentare anche il cliente più esigente.

La filosofia di produzione, con orgoglio 100% Made in Italy, si fonda da sempre sui concetti di qualità e sicurezza, che hanno permesso nel tempo di divenire fornitore qualificato per la linea accessori di diverse e prestigiose case automobilistiche.

Non da ultimo l'azienda ha recentemente sposato la politica delle energie rinnovabili con l'installazione di un impianto fotovoltaico, dimostrando la sensibilità verso un ambiente migliore.



MANAGEMENT SYSTEM CERTIFICATE

Certificato no./Certificate No.:
CERT-08620-2001-AQ-MIL-SINCERT

Data prima emissione/Initial date:
20 giugno 2001

Validità/Valid:
16 aprile 2016 - 16 aprile 2019

Si certifica che il sistema di gestione di/This is to certify that the management system of

FABBRI PORTATUTTO S.r.l. - Sede Legale

Via Belvedere Fogliense, 575 - 47836 Mondaino (RN) - Italy

e i siti come elencati nell'Appendix che accompagna questo certificato / and the sites as mentioned in the appendix accompanying this certificate

È conforme ai requisiti della norma per il Sistema di Gestione Qualità/
has been found to conform to the Quality Management System standard:

ISO 9001:2015

Questa certificazione è valida
per il seguente campo applicativo:

**Progettazione, produzione di portabagagli,
portasci e portabiciclette per il settore
automotive
(EA: 22)**

This certificate is valid
for the following scope:

**Design, manufacture of luggage racks, ski
racks and bike racks for automotive
application
(EA: 22)**

Luogo e Data/Place and date:
Vimercate (MB), 28 maggio 2018



Per l'Organismo di Certificazione/
For the Certification Body
DNV GL - Business Assurance
Via Energy Park, 14 - 20871 Vimercate
(MB) - Italy

Zeno Beltrami
Management Representative

La validità del presente Certificato è subordinata al rispetto delle condizioni contenute nel Contratto di Certificazione/
Lack of fulfilment of conditions as set out in the Certification Agreement may render this Certificate invalid.

DNV GL Business Assurance Italia S.r.l., Via Energy Park, 14 - 20871 Vimercate (MB) - Italy. TEL:039 68 99 905. www.dnvgl.it

Bici Exclusiv Deluxe.....	8	Adamantis 460-550.....	52
Exclusiv Ski & Board Deluxe.....	10	Cubo 360-460-500.....	53
Elektrobike Exclusiv Deluxe.....	12	Huski Ski & Board.....	54
Tech - Pro Bike.....	14	Kolumbus Ski & Board.....	56
Tech - Elektro Pro Bike.....	16	Kolumbus Deluxe.....	57
Free Bike.....	18	Sko.....	58
Easy Bike.....	20	Taco Ski & Board.....	59
Ski Pass Ski & Board.....	22	Ellisse Ski & Board.....	60
Ski Pass Magnum Ski & Board.....	23	Ellisse.....	61
Ski Pass Aluski.....	24	Aluski & Board Universale , Aluski & Board New.....	62
Bici OK - Modular - Van.....	26	Aluski 3-4-5-6-8.....	64
Bici OK 2 Elektro Bike.....	30	Optional Rialzo.....	65
Bici - Alu Bici Torbolino.....	32	Sicur 2-3-5.....	66
Alu Bici - Bici Torbole.....	33	Pannelli carichi sporgenti.....	67
Gringo Bici - Ski - Ski & Board.....	36	Unispider , Optional Ski & Board.....	68
Bici 1000 - 2000 - 3000 Alu - 3000 Alu New.....	38	Barro system.....	72
Bici OK Camper Base - Camper Top.....	40	Barro - Barro Alu.....	73
Reling - Alu Reling Universale.....	42	Kit Barro.....	74
Reling - Alu Reling Universale Barro.....	43	Optional Barro system.....	75
Reling Universale - Alu Reling Universale - Viva Base.....	44	Alu Cargo.....	77
ALU Viva 2 Black - Silver.....	46	Kit Alu Cargo.....	79
ALU Viva 2 Integrato Black - Silver.....	47	Alu Cargo Adaptor.....	80
Top Road per mancorrenti.....	48	Optional Alu Cargo system.....	81
Top Road.....	49	Alu Maxi Grondino.....	83
Top Road 30 x 20.....	50	Maxi Grondino.....	84
Top Road Barro.....	51	Modul Kit Grondino.....	85

ICON

GB LEGEND SYMBOLS

ES INTERPRETACION DE LOS SIMBOLOS

IT LEGENDA SIMBOLI

	Bicycle frame Bastidor bici Telaio Bicicletta		Alpine skis Esquí alpino Sci alpino		Classic Fixing Cierre Classsic Attacco Classico		Packing Embalaje Confezione		Bar dimensions Tamaño bares Dimensioni barre
	Bicycle Bicicleta Bicicletta		Cross-country skis Esquí de fondo Sci fondo		Fast Fixing Cierre Fast Attacco Rapido		Capacity Envase Capacità		Bar dimensions Tamaño bares Dimensioni barre
	Electric Bike Bicicleta electrica Bici Elettrica		Carving Skis Esquí carving Sci carving		Color Color Colore		Dual side		Bar dimensions Tamaño bares Dimensioni barre
	Length Longitud Lunghezza		Snowboard		Anti-theft knob Perilla antirrobo Pomello antifurto		Bar cross-section Sección barras Sezione barre		Foot Pie Piede
	Length • Height Longitud • Altura Lunghezza • Altezza		Plug Enchufe Spina		Lighting system Iluminación Fanaleria		Bar cross-section Sección barras Sezione barre		Pad Tope Tampone
	Length • Width • Height Longitud • Anchura • Altura Lunghezza • Larghezza • Altezza		Extra long cables Cables extra largos Cavi extra lunghi		Single gross weight Peso bruto pieza única Peso lordo singolo		Bar cross-section Sección barras Sezione barre		Bars Barras Barre
	Anti-theft Antirrobo Antifurto		Pre-assembled Premontado Premontato		Pairs gross weight Peso bruto par Peso lordo la coppia				

BICI EXCLUSIV DELUXE



ALUMINIUM!

CAN BE FOLDED UP // PRE-ASSEMBLED // ARC-WELDED ALUMINIUM
CERRABILE // PREMONTATO // ALUMINIO ELECTROSOLDADO
RICHIUDIBILE // PREMONTATO // ALLUMINIO ELETTRISALDATO

	EU Art. N°	CH Art. N°	AU - DK Art. N°									
Bici Exclusiv Deluxe 2	6201940	6201941	6201942	2	-	-	13	✓	-	Kg 20	1	Ø mm 30 - 50
Bici Exclusiv Deluxe 3	6201945	6201946	6201947	3	-	-	13	✓	-	Kg 22	1	Ø mm 30 - 50

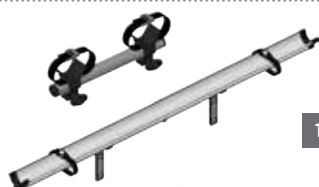

1

OPTIONAL Bici Plus Exclusiv (1)

	Art. N°				
Opt. Exclusiv Bici Plus	6201980	+1	Kg 2,0	1	Ø mm 30 - 50



2

OPTIONAL Ski & Board Exclusiv (2)

	Art. N°						
Opt. Exclusiv Ski & Board	6201965	6	4	3+2	✓	Kg 7,0	1



3

OPTIONAL Minibox Exclusiv (3)

	Art. N°				
Opt. Exclusiv Minibox	6201968	✓	lt 300	Kg 8,0	1



4

OPTIONAL Cavetti Bici (4)

	Art. N°		
Opt. Cavetti mm 295	6201795	1	Ø mm 24 - 35
Opt. Cavetti mm 370	6201796	1	Ø mm 44 - 55
Opt. Cavetti mm 400	6201797	1	Ø mm 54 - 65



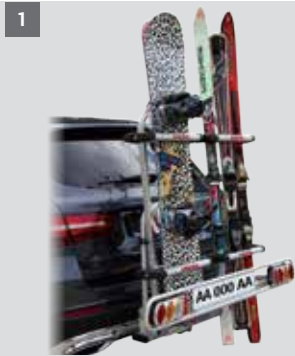

GB BICYCLE RACK FOR TOW BAR TO TRANSPORT UP TO 4 BICYCLES

- Foldable
- Tilting : the boot can be accessed at any time
- Convertible in ski and snowboard carrier with "Optional Exclusiv Ski&Board" (2) and in luggage carrier with "Optional Exclusiv Minibox" (3) (120x68x68 cm – 300 l)
- Patented rapid locking system : it ensures an easy and quick assembly on the tow bar
- "Optional Bici Plus" : to extend transportation from 2 to 3 or from 3 to 4 bicycles (1)
- Telescopic horizontally adjustable rails (min 900 mm <-> max 1350 mm)
- Antitheft : Antitheft locking system with one key only, the same key secures the bicycles and the bicycle carrier on the tow bar.
- Lightness and strength of the product guaranteed thanks to the use of arc-welded aluminium

- Fitting of bicycles using aluminium 360° rotating arms
- For wheels with a width up to 51 mm and wheel base of 1250 mm
- Supplied fixing cable of 320 mm for frames with 30-50 mm diameter
- Corresponding to rule ISO/PAS 11154:2006 Paragraph 5.3.4./Directive EEC 79/4888
- VCA Approval
- Maximum capacity 60 Kg
- Preassembled
- Telescopic regulation of the lighting system

ES PORTABICICLETAS PARA GANCHOS DE REMOLQUE PARA TRANSPORTAR HASTA 4 BICICLETAS

- Cerrable
- Plegable: el maletero permanece accesible en cualquier momento
- Transformable en portabicicletas & snowboard con el "Optional Exclusiv Ski&Board" (2) y en portaequipaje con el "Optional Exclusiv Minibox" (3) (cm 120x68x68 – Lt 300)
- Sistema de cierre rápido patentado: garantiza un montaje fácil y rápido sobre el gancho de remolque
- "Optional Bici Plus": permite aumentar el número de bicicletas de 2 a 3 o de 3 a 4 (1)
- Carriles telescópicos regulables horizontalmente (mín. 90 cm <-> máx. 135 cm)
- Antirrobo: sistema antirrobo con una sola llave, la misma llave protege las bicicletas y el portabicicletas sobre el gancho

- El uso de aluminio electrosoldado garantiza ligereza y robustez del producto
- Montaje de las bicicletas mediante brazos de aluminio giratorios a 360°
- Para ruedas de hasta 51 mm de ancho y de 1250 mm de paso
- Cable de fijación proporcionado de 320 mm para bastidores de 30-50 mm ø de diámetro
- Conforme a la norma ISO/ PAS 11154:2006 Apartado 5.3.4./Directiva CEE 79/488
- Homologación VCA
- Carga máxima kg. 60
- Premontado
- Regulación telescópica de los faros

IT PORTABICI PER GANCIO TRAINO PER TRASPORTARE FINO A 4 BICICLETTE

- Richiudibile
- Ribaltabile automaticamente: il bagagliaio rimane accessibile in qualsiasi momento
- Trasformabile in portasci & snowboard con l' "Optional Exclusiv Ski&Board" (2) per 6 paia di sci o per 4 snowboard o per 3 paia di sci e 2 snowboard e in portabagaglio con l' "Optional Exclusiv Minibox" (3) (cm 120x68x68 - Lt 300)
- Sistema di chiusura rapida brevettata: garantisce un facile e veloce montaggio sul gancio traino
- "Optional Bici Plus": per aumentare il numero di biciclette da 2 a 3 o da 3 a 4 (1)
- Rotaie telescopiche regolabili orizzontalmente (min 90 cm <-> max 135 cm)
- Antifurto: sistema di chiusura antifurto con una sola chiave, la stessa chiave protegge le biciclette e il portabici sul gancio

- Alluminio elettrosaldato e lavorazione di alta qualità garantiscono un'assoluta sicurezza anche in situazioni estreme
- Montaggio delle biciclette mediante bracci in alluminio rotanti di 360°
- Per ruote con larghezza fino a 51 mm e passo 1250 mm
- Per telai di diametro ø 30-50 mm con cavetto in dotazione mm 320
- Conforme alla norma ISO/ PAS 11154:2006 Paragraph 5.3.4./Direttiva CEE 79/488
- Omologazione VCA.
- Portata massima 60 Kg.
- Completamente assemblato, pronto per l'uso
- Regolazione telescópica dei fanali

EXCLUSIV SKI & BOARD DELUXE



ALUMINIUM!

PRE-ASSEMBLED // PREMONTADO // PREMONTATO
ARC-WELDED ALUMINIUM // ALUMINIO ELECTROSOLDADO // ALLUMINIO ELETTRISALDATO

	EU Art. N°	CH Art. N°	AU - DK Art. N°										
Exclusiv Ski & Board Deluxe	6201960	6201962	6201964	-	-	6	4	3+2	13	✓	Kg 22	1	-



OPTIONAL Bici Exclusiv 2 (1)

	Art. N°						
Optional Bici Exclusiv 2	6201975	2	1	✓	Kg 4,2	1	Ø 30 - 50 mm

OPTIONAL Bici Exclusiv 3 (2)

	Art. N°						
Optional Bici Exclusiv 3	6201976	3	2	✓	Kg 6,2	1	Ø 30 - 50 mm

OPTIONAL Kit Garage (3)

	Art. N°		
Optional Kit Garage	6201966	Kg 2,0	1



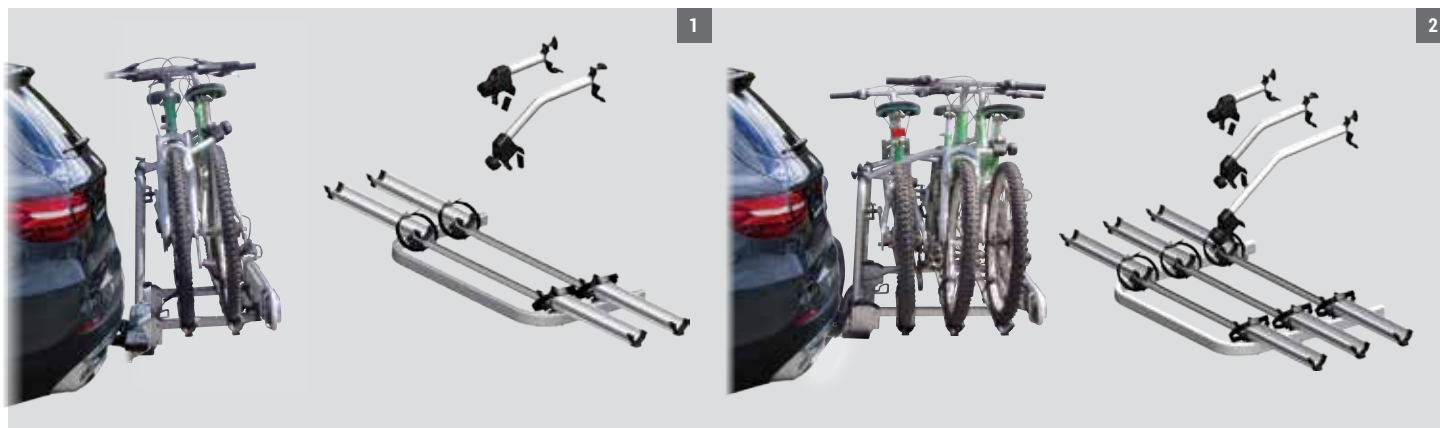

GB SKI AND SNOWBOARD RACK FOR TOW BAR

- Tilting : the boot can be accessed at any time
- For six pairs of skis or 4 snowboards or 3 pairs of skis and 2 snowboards
- Convertible in bicycle carrier with "Optional Bici Exclusiv 2 (1)" / "Optional Bici Exclusiv 3(2)"
- Patented rapid locking system : it ensures an easy and quick assembly on the tow bar
- Antitheft : Antitheft locking system with one key only, the same key secures the skis and the ski carrier on the tow bar.

- Lightness and strength of the product guaranteed thanks to the use of arc-welded aluminium
- Corresponding to rule ISO/PAS 11154:2006 Paragraph 5.3.4./Directive EEC 79/4888
- VCA Approval
- Preassembled
- Telescopic regulation of the lighting system

ES PORTAESQUÍ Y PORTASNOWBOARD PARA GANCHOS DE REMOLQUE

- Plegable: el maletero permanece accesible en cualquier momento
- Para 6 pares de esquís o 4 snowboard o 3 pares de esquís y 2 snowboard
- Transformable en portabicicletas con el "Optional Bici Exclusiv 2 (1)" / "Optional Bici Exclusiv 3 (2)"
- Sistema de cierre rápido patentado: garantiza un montaje fácil y rápido sobre el gancho de remolque
- Antirrobo: sistema antirrobo con una sola llave, la misma llave protege los

- esquís y el portaesquís sobre el gancho
- El uso de aluminio electrosoldado garantiza ligereza y robustez del producto
- Conforme a la norma ISO/ PAS 11154:2006 Apartado 5.3.4./Directiva CEE 79/488
- Homologación VCA
- Premontado
- Regulación telescópica de los faros

IT PORTASCI E PORTASNOWBOARD PER GANCIO TRAINO

- Ribaltabile
- Per 6 paia di sci o 4 snowboard oppure 3 paia di sci e 2 snowboard.
- Trasformabile in portabiciclette con l' "Optional Bici Exclusiv 2 (1)" / "Optional Bici Exclusiv 3 (2)" per 2 o 3 biciclette
- Sistema di chiusura rapida brevettata: garantisce un facile e veloce montaggio sul gancio traino
- Antifurto: sistema di chiusura antifurto con una sola chiave, la stessa chiave protegge gli sci ed il portasci sul gancio

- Leggerezza e robustezza del prodotto garantite grazie all'utilizzo dell'alluminio elettrosaldato
- Conforme alla norma ISO/ PAS 11154:2006 Paragraph 5.3.4./Direttiva CEE 79/488
- Omologazione VCA.
- Premontato
- Regolazione telescopica dei fanali.

ELEKTROBIKE EXCLUSIV DELUXE



ALUMINIUM!

CAN BE FOLDED UP // PRE-ASSEMBLED // ARC-WELDED ALUMINIUM
CERRABILE // PREMONTATO // ALUMINIO ELECTROSOLDADO
RICHIUDIBILE // PREMONTATO // ALLUMINIO ELETTRISALDATO

	EU Art. N°	CH Art. N°	AU - DK Art. N°										
Elektrobike Exclusiv Deluxe	6201981	6201982	6201983	2	-	-	-	13	✓	-	Kg 20,4	1	Ø mm 30 - 50



1

OPTIONAL Minibox Exclusiv (1)

	Art. N°				
Opt. Exclusiv Minibox	6201968	✓	lt 300	Kg 8,0	1



2

OPTIONAL Ski & Board Exclusiv (2)

	Art. N°						
Opt. Exclusiv Ski & Board	6201965	6	4	3+2	✓	Kg 7,0	1



3

OPTIONAL Rampa Exclusiv (3)

	Art. N°			
Optional Rampa	6201967	mm 1200	Kg 1,2	1



4

OPTIONAL Cavetti Bici (4)

	Art. N°		
Opt. Cavetti mm 295	6201795	1	Ø mm 24 - 35
Opt. Cavetti mm 370	6201796	1	Ø mm 44 - 55
Opt. Cavetti mm 400	6201797	1	Ø mm 54 - 65





1



2



3

GB BICYCLE RACK FOR TOW BAR TO TRANSPORT UP TO 2 ELECTRIC BIKES

- Foldable
- Tilting : the boot can be accessed at any time
- Convertible in ski and snowboard carrier with "Optional Exclusiv Ski&Board" (2) and in luggage carrier with "Optional Exclusiv Minibox" (1) (120x68x68 cm - 300 l)
- Patented rapid locking system : it ensures an easy and quick assembly on the tow bar
- Antitheft : antitheft locking system with one key only, the same key secures the bicycles and the bicycle carrier on the tow bar.
- Lightness and strength of the product guaranteed thanks to the use of arc-welded aluminium
- Fitting of bicycles using aluminium 360° rotating arms
- Length of the rail 1360 mm, for wheels with a width up to 51 mm and wheel base up to 1250 mm
- Supplied fixing cable of 320 mm for frames with 30-50 mm diameter
- Corresponding to rule ISO/PAS 11154:2006 Paragraph 5.3.4./Directive EEC 79/4888
- VCA Approval
- "Optional Rampa" : to facilitate loading heavy electrical bicycles on the bicycle carrier (3)
- Maximum capacity 60 Kg
- Preassembled
- Telescopic regulation of the lighting system

ES PORTABICICLETAS PARA GANCHOS DE REMOLQUE PARA TRANSPORTAR HASTA 2 BICICLETAS ELÉCTRICAS

- Cerrable
- Plegable: el maletero permanece accesible en cualquier momento
- Transformable en portaesquí & snowboard con el "Optional Exclusiv Ski&Board" (2) y en portaequipaje con el "Optional Exclusiv Minibox" (1) (cm 120x68x68 - Lt 300)
- Sistema de cierre rápido patentado: garantiza un montaje fácil y rápido sobre el gancho de remolque
- Antirrobo: sistema antirrobo con una sola llave, la misma llave protege las bicicletas y el portabicicletas sobre el gancho
- El uso de aluminio electrosoldado garantiza ligereza y robustez del producto
- Montaje de las bicicletas mediante brazos de aluminio giratorios a 360°
- Largo de la vía 1360 mm, para ruedas de hasta 51 mm de ancho y de 1250 mm de paso
- Cable de fijación proporcionado de 320 mm para bastidores de 30-50 mm ϕ de diámetro
- Conforme a la norma ISO/ PAS 11154:2006 Apartado 5.3.4./Directiva CEE 79/488
- Homologación VCA
- "Optional Rampa": para simplificar la subida de bicicletas eléctricas sobre el portabicicletas (3)
- Carga máxima kg. 60
- Premontado
- Regulación telescópica de los faros

IT PORTABICI PER GANCIO TRAINO PER TRASPORTARE FINO A 2 BICI ELETTRICHE

- Richiudibile
- Ribaltabile: il bagagliaio rimane accessibile in qualsiasi momento
- Trasformabile in portasci & snowboard con l' "Optional Exclusiv Ski&Board" (2) ed in portabagagli con l' "Optional Exclusiv Minibox" (1) (cm 120x68x68 - Lt 300)
- Sistema di chiusura rapida brevettata: garantisce un facile e veloce montaggio sul gancio traino
- Antifurto: sistema di chiusura antifurto con una sola chiave, la stessa chiave protegge le biciclette e il portabici sul gancio
- Leggerezza e robustezza del prodotto garantite grazie all'utilizzo dell'alluminio elettrosaldato
- Montaggio delle biciclette mediante bracci in alluminio rotanti di 360° M
- Lunghezza del binario 1360 mm, per ruote con larghezza fino a 51 mm e passo fino a 1250 mm
- Cavetto di fissaggio in dotazione di 320 mm per telai di diametro ϕ 30-50 mm
- Conforme alla norma ISO/ PAS 11154:2006 Paragraph 5.3.4./Direttiva CEE 79/488
- Omologazione VCA
- "Optional Rampa": per facilitare la salita di elettriche pesanti sul portabici (3)
- Portata massima 60 Kg.
- Preassemblato
- Regolazione telescopica dei fanali

+ CITY CRASH TEST

+ PATENTED

VCA
VEHICLE CERTIFICATION AGENCY

+ 2 YEARS WARRANTY

TECH-PRO BIKE



Tech-Pro Bike FAST
6201882



Tech-Pro Bike CLASSIC (1)
6201872



ALUMINIUM!

CAN BE FOLDED UP // PRE-ASSEMBLED // ARC-WELDED ALUMINIUM
CERRABLE // PREMONTADO // ALUMINIO ELECTROSOLDADO
RICHIUDIBILE // PREMONTATO // ALLUMINIO ELETTRORSALDATO

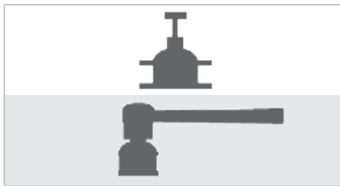

	Art. N°							
TECH-PRO BIKE Attacco Classic	6201872	3	—	Kg 14	1	Ø 30 - 50 mm	13	—
TECH-PRO BIKE Attacco Fast	6201882	3	—	Kg 15,5	1	Ø 30 - 50 mm	13	✓

OPTIONAL POMELO

	Art. N°	
Optional Pomello con Antifurto (1 pz.)	6201901	1

OPTIONAL Cavetti Bici

	Art. N°		
Opt. Cavetti mm 295	6201795	1	Ø mm 24 - 35
Opt. Cavetti mm 370	6201796	1	Ø mm 44 - 55
Opt. Cavetti mm 400	6201797	1	Ø mm 54 - 65





GB BICYCLE CARRIER FOR TOW BAR WITH ADJUSTABLE MTB RAIL FOR CARRYING UP TO 3 BICYCLES

- Foldable when removed from the tow bar
- Tilting : the boot can be accessed at any time
- Tech-Pro Bike Classic : with locking screw for a perfect grip of the bicycle carrier on the tow bar. Key Ch24 included in the pack (1)
- Tech-Pro Bike Fast with quick locking system and anti theft
- Lightness and strength of the product guaranteed thanks to the use of arc-welded aluminium
- Fitting of bicycles using aluminium 360° rotating arms
- Supplied fixing cable of 320 mm for frames with 30-50 mm diameter
- Telescopic MTB rails fitted with quick-insert straps for fixing the wheels
- Maximum encumbrance of the rail 1260 mm : for wheels with 1380 mm wheel base
- Maximum capacity 45 Kg
- VCA Approval
- Preassembled
- Telescopic regulation of the lighting system and adjustable aluminium number plate holder
- Anti theft knob with keys available as an option

ES PORTABICICLETAS PARA GANCHOS DE REMOLQUE PARA TRANSPORTAR HASTA 3 BICICLETAS

- Cerrable cuando desmontado
- Plegable: el maletero permanece accesible en cualquier momento
- Tech-Pro Bike Classic: con tornillo de ajuste para un perfecto agarre del portabicicletas al gancho de remolque. Tornillo Ch24 incluido (1)
- Tech-Pro Bike Fast con sistema de cierre rápido y antirrobo
- El uso de aluminio electrosoldado garantiza ligereza y robustez del producto
- Montaje de las bicicletas mediante brazos de aluminio giratorios a 360°
- Cable de fijación proporcionado de 320 mm para bastidores de 30-50 mm ϕ de diámetro
- Canales MTB telescópicos con correa a inserción rápida para la fijación de las ruedas
- Dimensiones de la vía max 1260 mm: para ruedas con paso de 1380 mm
- Carga máxima kg. 45
- Homologación VCA
- Premontado
- Regulación telescópica de los faros y portaplaca regulable de aluminio
- Pomo antirrobo con llaves opcional

IT PORTABICI PER GANCIO TRAINO CON CANALINA MTB REGOLABILE PER TRASPORTARE FINO A 3 BICICLETTE

- Richiudibile quando smontato
- Ribaltabile: Il bagagliaio rimane accessibile in qualsiasi momento
- Tech-Pro Bike Classic: con vite di serraggio per una perfetta aderenza del portabiciclette sul gancio traino. Chiave Ch24 inclusa nella confezione (1)
- Tech-Pro Bike Fast con sistema di chiusura rapida ed antifurto
- Leggerezza e robustezza del prodotto garantite grazie all'utilizzo dell'alluminio elettrosaldato
- Montaggio delle biciclette mediante bracci in alluminio rotanti di 360°
- Cavetto di fissaggio in dotazione di 320 mm per telai di diametro ϕ 30-50 mm
- Canaline MTB telescopiche munite di cinghiette ad inserto rapido per il fissaggio delle ruote
- Ingombro del binario max 1260 mm: per ruote con passo 1380 mm
- Portata massima 45 Kg
- Omologazione VCA.
- Preassemblato
- Regolazione telescopica dei fanali e porta targa orientabile in alluminio
- Pomello antifurto con chiavi disponibile come optional

+ 2 YEARS WARRANTY

VCA
VEHICLE CERTIFICATION AGENCY

TECH-ELEKTRO PRO BIKE



ALUMINIUM!

CAN BE FOLDED UP // PRE-ASSEMBLED // ARC-WELDED ALUMINIUM
CERRABILE // PREMONTATO // ALUMINIO ELECTROSOLDADO
RICHIUDIBILE // PREMONTATO // ALLUMINIO ELETTRISOLDATO



**TECH-ELEKTROPRO BIKE
Attacco Fast**

Art. N°							
6201885	2	2	Kg 14,4	1	∅ 30 - 50 mm	13	✓



OPTIONAL POMELO

Art. N°	
6201901	1

**Optional Pomello
con Antifurto (1 pz.)**



**OPTIONAL
Cavetti Bici**

Art. N°		
6201795	1	∅ mm 24 - 35
6201796	1	∅ mm 44 - 55
6201797	1	∅ mm 54 - 65

Opt. Cavetti mm 295

Opt. Cavetti mm 370

Opt. Cavetti mm 400



GB BICYCLE CARRIER FOR TOW BAR WITH ADJUSTABLE MTB RAIL FOR CARRYING UP TO 2 ELECTRICAL BICYCLES

- Foldable when removed from the tow bar
- Tilting : the boot can be accessed at any time
- Tech-Elektro Pro Bike Fast with quick locking system and anti theft
- Lightness and strength of the product guaranteed thanks to the use of arc-welded aluminium
- Fitting of bicycles using aluminium 360° rotating arms
- Supplied fixing cable of 320 mm for frames with 30-50 mm diameter
- Telescopic MTB rails fitted with quick-insert straps for fixing the wheels
- Maximum encumbrance of the rail 1260 mm : for wheels with up to 1380 mm wheel base
- Maximum capacity 45 Kg
- VCA Approval
- Preassembled
- Telescopic regulation of the lighting system and adjustable aluminium number plate holder
- Anti theft knob with keys available as an option

ES PORTABICICLETAS PARA GANCHOS DE REMOLQUE PARA TRANSPORTAR HASTA 2 BICICLETAS ELÉCTRICAS

- Cerrable cuando desmontado
- Plegable: el maletero permanece accesible en cualquier momento
- Tech-Pro Bike Fast con sistema de cierre rápido y antirrobo
- El uso de aluminio electrosoldado garantiza ligereza y robustez del producto
- Montaje de las bicicletas mediante brazos de aluminio giratorios a 360°
- Cable de fijación proporcionado de mm 320 para bastidores de 30-50 mm ϕ de diámetro
- Canales MTB telescópicos con correa a inserción rápida para la fijación de las ruedas
- Dimensiones de la vía máx. 1260 mm: para ruedas con paso de hasta 1380 mm
- Carga máxima kg. 45
- Homologación VCA
- Premontado
- Regulación telescópica de los faros y portaplaca regulable de aluminio
- Pomo antirrobo con llaves opcional

IT PORTABICI PER GANCIO TRAINO CON CANALINA MTB REGOLABILE PER TRASPORTARE FINO A 2 BICICLETTE ELETTRICHE

- Richiudibile quando smontato
- Ribaltabile: il bagagliaio rimane accessibile in qualsiasi momento
- Tech-Elektro Pro Bike Fast con sistema di chiusura rapida ed antifurto
- Leggerezza e robustezza del prodotto garantite grazie all'utilizzo dell'alluminio elettrosaldato.
- Montaggio delle biciclette mediante bracci in alluminio rotanti di 360°
- Cavetto di fissaggio in dotazione di 320 mm per telai di diametro ϕ 30-50 mm
- Canaline MTB telescopiche munite di cinghietta ad inserto rapido per il fissaggio delle ruote
- Ingombro del binario max 1260 mm: per ruote con passo fino a 1380 mm
- Portata massima 45 Kg
- Omologazione VCA.
- Preassemblato
- Regolazione telescópica dei fanali e porta targa orientabile in alluminio
- Pomello antifurto con chiavi disponibile come optional.

+ 2 YEARS WARRANTY

VCA
VEHICLE CERTIFICATION AGENCY

FREE BIKE



Free Bike FAST
6201881

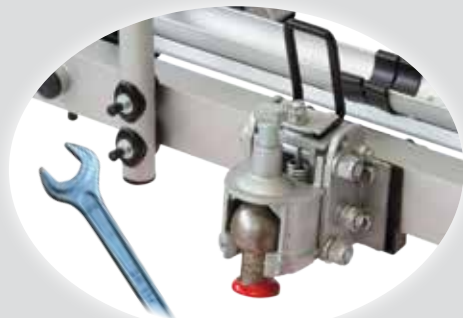

Free Bike CLASSIC (1)
6201873



ALUMINIUM!

CAN BE FOLDED UP // PRE-ASSEMBLED // ARC-WELDED ALUMINIUM
CERRABILE // PREMONTATO // ALUMINIO ELECTROSOLDADO
RICHIUDIBILE // PREMONTATO // ALLUMINIO ELETTRORSALDATO

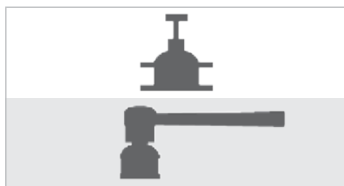

	Art. N°							
FREE BIKE Attacco Classic	6201873	3	—	Kg 14	1	Ø 30 - 50 mm	13	—
FREE BIKE Attacco Fast	6201881	3	—	Kg 15,5	1	Ø 30 - 50 mm	13	✓

OPTIONAL POMELLO

	Art. N°	
Optional Pomello con Antifurto (1 pz.)	6201901	1

OPTIONAL Cavetti Bici

	Art. N°		
Opt. Cavetti mm 295	6201795	1	Ø mm 24 - 35
Opt. Cavetti mm 370	6201796	1	Ø mm 44 - 55
Opt. Cavetti mm 400	6201797	1	Ø mm 54 - 65





GB BICYCLE CARRIER FOR TOW BAR WITH ADJUSTABLE RAIL FOR CARRYING UP TO 3 BICYCLES

- Foldable
- Tilting : the boot can be accessed at any time
- Free Bike Classic with locking screw for a perfect grip of the bicycle carrier on the tow bar. Key included in the pack (1)
- Free Bike Fast with quick locking system and antitheft. Automatically tilting : the boot can be accessed at any time
- Lightness and strength of the product guaranteed thanks to the use of arc-welded aluminium
- Fitting of bicycles using aluminium 360° rotating arms
- Supplied fixing cable of 320 mm for frames with 30-50 mm diameter
- Telescopic horizontally adjustable rails (min 720 mm <-> max 1240 mm), for wheels with a width up to 51 mm and wheel base up to 1140 mm
- Maximum capacity 45 Kg
- VCA Approval
- Preassembled
- Telescopic regulation of the lighting system and adjustable aluminium number plate holder
- Antitheft knob with keys available as an option

ES PORTABICICLETAS PARA GANCHOS DE REMOLQUE CON CARRILES REGULABLES PARA TRANSPORTAR HASTA 3 BICICLETAS

- Cerrable
- Plegable: el maletero permanece accesible en cualquier momento
- Free Bike Classic con tornillo de ajuste para un perfecto agarre del portabicicletas al gancho de remolque. Llave incluida (1)
- Free Bike Fast con cierre rápido y antirrobo. Plegable automáticamente: el maletero permanece accesible en cualquier momento
- El uso de aluminio electrosoldado garantiza ligereza y robustez del producto
- Montaje de las bicicletas mediante brazos de aluminio giratorios a 360°
- Cable de fijación proporcionado de 320 mm para bastidores de 30-50 mm ø de diámetro
- Carriles telescópicos regulables horizontalmente (mín. 720 mm <-> máx. 1240 mm) para ruedas de hasta 51 mm de ancho y de 1250 mm de paso
- Carga máxima kg. 45
- Homologación VCA
- Premontado
- Regulación telescópica de los faros y portaplaca regulable de aluminio
- Pomo antirrobo con llaves opcional

IT PORTABICI PER GANCIO TRAINO CON CANALINA REGOLABILE PER TRASPORTARE FINO A 3 BICICLETTE

- Richiudibile.
- Ribaltabile: Il bagagliaio rimane accessibile in qualsiasi momento.
- Free Bike Classic con vite di serraggio per una perfetta aderenza del portabiciclette sul gancho traino. Chiave inclusa nella confezione (1)
- Free Bike Fast con sistema di chiusura rapida ed antifurto. Ribaltabile automaticamente: il bagagliaio rimane accessibile in qualsiasi momento
- Leggerezza e robustezza del prodotto garantite grazie all'utilizzo dell'alluminio elettrosaldato
- Montaggio delle biciclette mediante bracci in alluminio rotanti di 360°
- Cavetto di fissaggio in dotazione di 320 mm per telai di diametro ø 30-50 mm
- Rotaie telescopiche regolabili orizzontalmente (min 720 mm <-> max 1240 mm) per ruote con larghezza fino a 51 mm e passo fino a 1140
- Portata massima 45 Kg
- Omologazione VCA
- Preassemblato
- Regolazione telescopica dei fanali e porta targa orientabile in alluminio
- Pomello antifurto con chiavi disponibile come optional

+ 2 YEARS WARRANTY

VCA
VEHICLE CERTIFICATION AGENCY

EASY BIKE



Easy Bike FAST
6201883



Easy Bike CLASSIC (1)
6201871



ALUMINIUM!

PRE-ASSEMBLED // ARC-WELDED ALUMINIUM
PREMONTADO // ALUMINIO ELECTROSOLDADO
PREMONTATO // ALLUMINIO ELETTROSALDATO

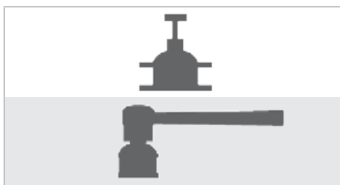

	Art. N°							
Easy Bike Attacco Classic	6201871	3	—	Kg 11	1	Ø 30 - 50 mm	13	—
Easy Bike Attacco Fast	6201883	3	—	Kg 14.2	1	Ø 30 - 50 mm	13	✓



GB BICYCLE CARRIER FOR TOW BAR FOR CARRYING UP TO 3 BICYCLES

- Foldable when removed from the tow bar
- Easy Bike Classic with locking screw for a perfect grip of the bicycle carrier on the tow bar. Key Ch24 included in the pack (1)
- Easy Bike with quick locking system and anti-theft. Automatically tilting : the boot can be accessed at any time
- Lightness and strength of the product guaranteed thanks to the use of arc-welded aluminium
- Fitting of bicycles using aluminium 360° rotating arms
- Rail 1200 mm long, for wheels with a width up to 51 mm and wheel base up to 1100 mm
- Maximum capacity 45 Kg
- VCA Approval
- Preassembled
- Adjustable lighting system and aluminium number plate holder

ES PORTABICICLETAS PARA GANCHOS DE REMOLQUE PARA TRANSPORTAR HASTA 3 BICICLETAS

- Cerrable cuando desmontado
- Easy Bike Classic con tornillo de ajuste para un perfecto agarre del portabicicletas al gancho de remolque. Llave incluida (1)
- Easy Bike Fast con cierre rápido y antirrobo. Plegable automáticamente: el maletero permanece accesible en cualquier momento
- El uso de aluminio electrosoldado garantiza ligereza y robustez del producto
- Montaje de las bicicletas mediante brazos de aluminio giratorios a 360°
- Largo de la vía 1200 mm, para ruedas de hasta 51 mm de ancho y de hasta 1100 mm de paso
- Carga máxima kg. 45
- Homologación VCA
- Preassemblado Premontado
- Faros y portaplaca regulable de aluminio

IT PORTABICI PER GANCIO TRAINO PER TRASPORTARE FINO A 3 BICICLETTE

- Richiudibile quando smontato
- Easy Bike Classic con vite di serraggio per una perfetta aderenza del portabiciclette sul gancio traino. Chiave Ch24 inclusa nella confezione (1).
- Easy Bike Fast con sistema di chiusura rapida ed antifurto. Ribaltabile automaticamente: il bagagliaio rimane accessibile in qualsiasi momento
- Leggerezza e robustezza del prodotto garantite grazie all'utilizzo dell'alluminio elettrosaldato
- Montaggio delle biciclette mediante bracci in alluminio rotanti di 360°
- Lunghezza del binario 1200 mm, per ruote con larghezza fino a 51 mm e passo fino a 1100 mm
- Portata massima 45 Kg
- Omologazione VCA
- Preassemblato
- Fanali e porta targa orientabili in alluminio

+ 2 YEARS WARRANTY

VCA
VEHICLE CERTIFICATION AGENCY

SKI PASS

SKI & BOARD



Adapter



Ski Pass Ski & Board FAST
6201879



Ski Pass Ski & Board CLASSIC (1)
6201874

ALUMINIUM!

PRE-ASSEMBLED // ARC-WELDED ALUMINIUM
PREMONTADO // ALUMINIO ELECTROSOLDADO
PREMONTATO // ALLUMINIO ELETTROSALDATO

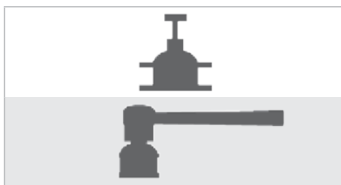

	Art. N°						
SKI PASS SKI & BOARD Attacco Classic	6201874	4	2	✓	Kg 15,2	1	13
SKI PASS SKI & BOARD Attacco Fast	6201879	4	2	✓	Kg 16,7	1	13

SKI PASS MAGNUM

SKI & BOARD



ALUMINIUM!



6201880

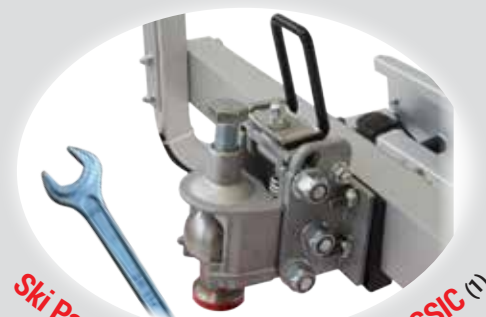

6201878

PRE-ASSEMBLED // ARC-WELDED ALUMINIUM
 PREMONTADO // ALUMINIO ELECTROSOLDADO
 PREMONTATO // ALLUMINIO ELETTRISALDATO

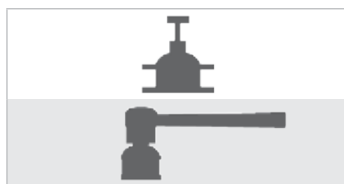

	Art. N°						
SKI PASS SKI & BOARD MAGNUM Attacco Classic	6201878	6	4	✓	Kg 18,6	1	13
SKI PASS SKI & BOARD MAGNUM Attacco Fast	6201880	6	4	✓	Kg 20,1	1	13

+ 2 YEARS WARRANTY



SKI PASS ALUSKI



Adapter



Ski Pass Aluski FAST
6201884



Ski Pass Aluski CLASSIC (1)
6201875

ALUMINIUM!

PRE-ASSEMBLED // ARC-WELDED ALUMINIUM
PREMONTADO // ALUMINIO ELECTROSOLDADO
PREMONTATO // ALLUMINIO ELETTRISALDATO

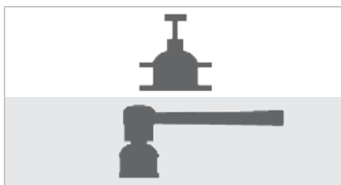

	Art. N°						
SKI PASS ALUSKI Attacco Classic	6201875	4	2	✓	Kg 15,2	1	13
SKI PASS ALUSKI Attacco Fast	6201884	4	2	✓	Kg 16,7	1	13



GB UNIVERSAL SKI AND SNOW-BOARD CARRIER FOR TOW BAR

- Tilting
- Antitheft : locking system of the ski carrier with key antitheft and steel safety hook for skis
- Equipped with 2 buckles and 2 straps with scratch resistant plasticised hooks (including Adapter)
- Ski Pass Classic with locking screw for a perfect grip of the ski carrier on the tow bar. Key Ch24 included in the pack (1)

- Ski Pass Fast with quick locking system and antitheft. Automatically tilting : the boot can be accessed at any time
- Lightness and strength of the product guaranteed thanks to the use of arc-welded aluminium
- Number plate holder with lighting
- Preassembled
- VCA Approval

ES PORTAESQUÍS Y PORTASNOWBOARD UNIVERSAL PARA GANCHOS DE REMOLQUE

- Plegable
- Antirrobo: sistema de cierre del portaesquí con llave antirrobo y gancho sujetabici de seguridad de acero
- Dotado de 2 hebillas y 2 correas con ganchos plastificados antirayado (incl. Adaptador)
- Ski Pass Classic con tornillo de ajuste para un perfecto agarre del portaesquí al gancho de remolque. Llave incluida (1)

- Ski Pass Fast con cierre rápido y antirrobo. Plegable automáticamente: el maletero permanece accesible en cualquier momento
- El uso de aluminio electrosoldado garantiza ligereza y robustez del producto
- Portaplaca con iluminación
- Premontado
- Homologación VCA

IT PORTASCI E SNOWBOARD UNIVERSALE PER GANCIO TRAINO

- Ribaltabile
- Antifurto: sistema di chiusura del portasci con chiave antifurto e gancio fermasci di sicurezza in acciaio
- Provvisto di 2 fibbie e 2 cinghie con ganci plastificati antigraffio (incl. Adapter)
- Ski Pass Classic con vite di serraggio per una perfetta aderenza del portasci sul gancio traino. Chiave Ch24 inclusa nella confezione (1)

- Ski Pass Fast con sistema di chiusura rapida ed antifurto. Ribaltabile automaticamente: il bagagliaio rimane accessibile in qualsiasi momento
- Leggerezza e robustezza del prodotto garantite grazie all'utilizzo dell'alluminio elettrosaldato
- Porta targa con illuminazione
- Preassemblato
- Omologazione VCA

+ 2 YEARS WARRANTY

VCA
VEHICLE CERTIFICATION AGENCY

BICI OK

MODULAR

ALUMINIUM!



Adapter



Viti BLOCK

ARC-WELDED ALUMINIUM // ALUMINIO ELECTROSOLDADO // ALLUMINIO ELETTRORSALDATO

	Art. N°						
Bici Ok 2 Modular	6201854	–	2	–	Kg 6,2	1	Ø mm 30 - 55
Bici Ok 3 Modular	6201855	–	3	–	Kg 7,4	1	Ø mm 30 - 55



OPTIONAL CANALINA MTB

	Art. N°		
Optional Canalina MTB	6201863	Kg 1	1



OPTIONAL BRACETTO FERMABICI

	Art. N°		
Optional Bracetto fermabici Corto	6201790	Kg 0,2	1
Optional Bracetto fermabici Medio	6201791	Kg 0,28	1
Optional Bracetto fermabici Lungo	6201792	Kg 0,35	1

BICI OK

STANDARD / SUV

ALUMINIUM!



STANDARD
6201801

MTB STANDARD
6201814

MTB SUV
6201822

ARC-WELDED ALUMINIUM // ALUMINIO ELECTROSOLDADO // ALLUMINIO ELETTRISALDATO



VITI BLOCK



ADAPTER



OPTIONAL CANALINA MTB

	Art. N°	👤	📦
Optional Canalina MTB	6201863	Kg 1	1

OPTIONAL POMELO

	Art. N°	📦
Optional Pomello con Antifurto (1 pz.)	6201901	1

OPTIONAL Cavetti Bici

	Art. N°	📦	🚲
Opt. Cavetti mm 295	6201795	1	∅ mm 24 - 35
Opt. Cavetti mm 370	6201796	1	∅ mm 44 - 55
Opt. Cavetti mm 400	6201797	1	∅ mm 54 - 65



	Art. N°	🔧	🚲	🚲	👤	📦	🚲	↑ H Telaio H frame
Bici Ok 2 incl. Adapter	6201800	-	2	-	Kg 5,9	1	∅ mm 30 - 50	750 mm
Bici Ok 3 incl. Adapter	6201801	-	3	-	Kg 7	1	∅ mm 30 - 50	750 mm
Bici Ok 3 MTB incl. Adapter	6201814	-	3	-	Kg 7,5	1	∅ mm 30 - 50	750 mm
Bici Ok 3 MTB - SUV incl. Adapter	6201822	-	3	-	Kg 7,6	1	∅ mm 30 - 50	900 mm

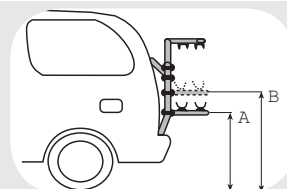

GB 6201822
Rails can be adjusted in height to prevent covering the license plate

ES 6201822
marco de soporte de conducto ajustable en altura para evitar el oscurecimiento de la matrícula

IT 6201822
Rotae regolabili in due posizioni (A+B) per evitare la copertura della targa

+ 2 YEARS WARRANTY

+ CITY CRASH TEST

BICI OK VAN



VAN
6201811



MTB VAN
6201816

ARC-WELDED ALUMINIUM // ALUMINIO ELECTROSOLDADO // ALLUMINIO ELETTRORSALDATO



VITI BLOCK



ADAPTER



OPTIONAL CANALINA MTB

Optional
Canalina MTB

Art. N°



6201863

Kg 1

1

OPTIONAL POMELLO

Optional Pomello
con Antifurto (1 pz.)

Art. N°



6201901

1

OPTIONAL Cavetti Bici

Opt. Cavetti mm 295

Art. N°



6201795

1

Ø mm
24 - 35

Opt. Cavetti mm 370

6201796

1

Ø mm
44 - 55

Opt. Cavetti mm 400

6201797

1

Ø mm
54 - 65

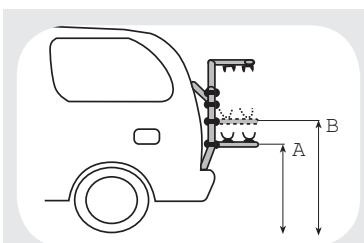

GB

Rails can be adjusted in height to prevent covering the license plate

ES

marco de soporte de conducto ajustable en altura para evitar el oscurecimiento de la matrícula

IT

Rotaie regolabili in due posizioni (A+B) per evitare la copertura della targa



GB REAR BIKE RACKS FOR UP TO 3 BICYCLES

- Bici OK series : rear bike rack for the carriage of 2 or 3 bicycles, designed for cars with standard bonnet and tailgate as well as for cars with spoiler, glass rear window or plastic bumpers (see Application list on www.fabbri.info)
- Foldable when travelling empty
- Lightness and strength of the product guaranteed thanks to the use of arc-welded aluminium
- Fitting of bicycles using aluminium 360° rotating arms
- With "Viti Block" system for protecting the aluminium when tightening the screw
- With 6 dual beam notched joints made of ABS for a perfect grip even on road bumps and unpaved roads
- Equipped with 6 buckles and 6 straps with scratch resistant plasticised hooks (including Adapter)
- With sturdy straps and buckles shimmed with scratch resistant rubber for fixing bike wheels

- Bici Ok/Ok Van: Supplied 320 mm fixing cable for 30-50 mm diameter
- Bici OK MODULAR/STD/SUV/VAN - Rail length : 1250 mm, for wheels with a width up to 51 mm and wheel base up to 1150 mm
- Bici OK MTB STD/SUV/VAN - Rail length : 1250 mm, for wheels with a width up to 63 mm and wheel base up to 1150 mm
- Not covering the licence plate
- Preassembled
- Antitheft knob with keys available as an option
- Bici OK 2/3: Corresponding to rule ISO/PAS 11154:2006 Paragraph 5.3.4 Directive EEC 79/4888
- Bici OK Modular/Van: Corresponding to rule DIN 75302

ES PORTABICICLETAS TRASERO PARA TRANSPORTAR HASTA 3 BICICLETAS

- Serie Bici Ok: portabicicletas trasero para el transporte de 2 o 3 bicicletas, fabricado para vehículos con puerta trasera estándar y también para vehículos con spoiler, portón con cristal trasero sin marco, paragolpe de plástico (Application List in www.fabbri.info)
- Cerrable cuando viaja vacío
- El uso de aluminio electrosoldado garantiza ligereza y robustez del producto
- Montaje de las bicicletas mediante brazos de aluminio giratorios a 360°
- Con sistema "Viti Block" para proteger el aluminio al apretar los tornillos
- Con 6 articulaciones dentadas en ABS con doble radio para un perfecto cierre incluso en cambios de rasante y carreteras sin asfaltar
- Con 6 hebillas y 6 correas con ganchos plastificados antirayado (incl. Adaptador)
- Con correas y hebillas resistentes engrosadas con goma antirayado para la fijación de las ruedas de la bici

- Bici Ok/Ok Van: Cable de fijación proporcionado de 320 mm para bastidores de 30-50 mm ϕ de diámetro
- Bici OK MODULAR/STD/SUV/VAN - Largo de la vía 1250 mm, para ruedas de hasta 51 mm de ancho y de 1100 mm de paso
- Bici OK MTB STD/SUV/VAN - Largo de la vía 1250 mm, para ruedas de hasta 63 mm de ancho y de 1150 mm de paso
- No cubre la placa de la matrícula
- Premontado
- Pomo antirrobo con llaves opcional
- Bici OK 2/3: Conforme a la norma ISO/ PAS 11154:2006 Apartado 5.3.4. Directiva CEE 79/488
- Bici OK Modular/Van: Conforme a la Norma DIN 75302

IT PORTABICICLETTE POSTERIORE PER TRASPORTARE FINO A 3 BICICLETTE

- Serie Bici Ok : portabici posteriore per il trasporto di 2 o 3 biciclette, realizzato per vetture con cofano o portellone standard così come per vetture con spoiler, lunotti di vetro o paraurti in plastica (v. Application List in www.fabbri.info)
- Richiudibile quando viaggia a vuoto
- Leggerezza e robustezza del prodotto garantite grazie all'utilizzo dell'alluminio elettrosaldato
- Montaggio delle biciclette mediante bracci in alluminio rotanti di 360°
- Con sistema "Viti Block" per la protezione dell'alluminio nel serraggio delle viti
- Con 6 snodi dentellati in ABS con doppio raggio per una perfetta tenuta anche su dossi stradali e strade sterrate
- Con 6 fibbie e 6 cinghie con ganci plastificati antiraffio (incl. Adapter)
- Con cinghiette e fibbiette robuste spessorati in gomma antiraffio per fissaggio ruote bici

- Bici Ok/Ok Van: Cavetto di fissaggio del telaio in dotazione di 320 mm, per diametro ϕ 30-50 mm
- Bici OK MODULAR/STD/SUV/VAN - Lunghezza del binario: 1250 mm, per ruote con larghezza fino a 51 mm e passo fino a 1100 mm
- Bici OK MTB STD/SUV/VAN - Lunghezza del binario: 1250 mm, per ruote con larghezza fino a 63 mm e passo fino a 1150 mm
- Non copre la targa
- Preassemblato
- Pomello antifurto con chiavi disponibile come optional
- Bici OK 2/3: Conforme alla norma ISO/ PAS 11154:2006 Paragraph 5.3.4. Direttiva CEE 79/488
- Bici OK Modular/Van: Conforme alla Normativa DIN 75302

+ 2 YEARS WARRANTY

BICI OK 2 ELEKTROBIKE

STANDARD / SUV / VAN



STANDARD
6201812

SUV
6201824

VAN
6201826

ARC-WELDED ALUMINIUM // ALUMINIO ELECTROSOLDADO // ALLUMINIO ELETTRISALDATO



VITI BLOCK



ADAPTER



OPTIONAL POMELLO

	Art. N°	
Optional Pomello con Antifurto (1 pz.)	6201901	1



OPTIONAL Cavetti Bici

	Art. N°		
Opt. Cavetti mm 295	6201795	1	Ø mm 24 - 35
Opt. Cavetti mm 370	6201796	1	Ø mm 44 - 55
Opt. Cavetti mm 400	6201797	1	Ø mm 54 - 65

	Art. N°							H Telaio H Frame
BICI OK 2 Elektrobike	6201812	✓	2	2	Kg 6,5	1	Ø mm 30 - 50	750 mm
BICI OK 2 Elektrobike SUV	6201824	✓	2	2	Kg 6,6	1	Ø mm 30 - 50	900 mm
BICI OK 2 Elektrobike VAN	6201826	✓	2	2	Kg 6,7	1	Ø mm 30 - 50	1050 mm

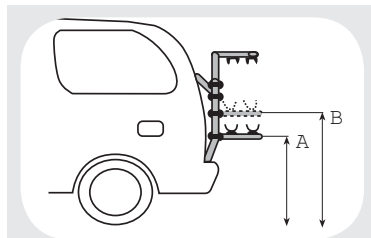

GB 6201824 - 6201826

Rails can be adjusted in height to prevent covering the license plate

ES 6201824 - 6201826

marco de soporte de conducto ajustable en altura para evitar el oscurecimiento de la matrícula

IT 6201824 - 6201826

Rotaie regolabili in due posizioni (A+B) per evitare la copertura della targa



GB REAR BICYCLE CARRIER WITH MTB RAIL FOR CARRYING UP TO 2 ELECTRICAL BICYCLES

- Rear bike rack for the carriage of 2 bicycles/electrical bicycles, designed for cars with standard/suv/van bonnet and tailgate as well as for cars with spoiler, glass rear window or plastic bumpers (see Application list on www.fabbri.info)
- Foldable when travelling empty
- Antitheft knob with keys available as an option
- Lightness and strength of the product guaranteed thanks to the use of arc-welded aluminium
- Fitting of bicycles using aluminium 360° rotating arms
- With "Viti Block" system for protecting the aluminium when tightening the screw
- With 6 dual beam notched joints made of ABS for a perfect grip even on road bumps and unpaved roads
- Equipped with 6 buckles and 6 straps for fixing on cars with scratch resistant plasticised hooks (including Adapter)
- With sturdy straps and buckles shimmed with scratch resistant rubber for fixing bike wheels
- MTB rail 1250 mm long fitted with quick-insert straps for fixing the wheels with wheelbase up to 1150 mm
- Supplied 320 mm fixing cable for 30-50 mm diameter
- Not covering the licence plate
- Maximum capacity 45 Kg
- Corresponding to rule DIN 75302

ES PORTABICICLETAS TRASERO PARA TRANSPORTAR HASTA 2 BICICLETAS ELÉCTRICAS

- Portabicicletas trasero para el transporte de 2 bicicletas/bicicletas eléctricas, fabricado para vehículos con puerta trasera estándar/suv/van y también para vehículos con spoiler, portón con cristal trasero sin marco, paragolpe de plástico (Application List in www.fabbri.info)
- Cerrable cuando viaja vacío
- Pomo antirrobo con llaves opcional
- El uso de aluminio electrosoldado garantiza ligereza y robustez del producto
- Montaje de las bicicletas mediante brazos de aluminio giratorios a 360°
- Con sistema "Viti Block" para proteger el aluminio al apretar los tornillos
- Con 6 articulaciones dentadas en ABS con doble radio para un perfecto cierre incluso en cambios de rasante y carreteras sin asfaltar
- Con 6 hebillas y 6 correas para la fijación sobre el vehículo con ganchos plastificados antirayado (incl. Adaptador)
- Con correas y hebillas resistentes engrosadas con goma antirayado para la fijación de las ruedas de la bici
- Canal MTB de 1250 mm con correas a inserción rápida para la fijación de las ruedas, para ruedas de hasta 1150 mm de paso
- Cable de fijación proporcionado de 320 mm para bastidores de 30-50 mm ϕ de diámetro
- No cubre la placa de la matrícula
- Carga máxima kg. 45
- Conforme a la Norma DIN 75302

IT PORTABICI POSTERIORE CON CANALINA MTB PER TRASPORTARE FINO A 2 BICI ELETTRICHE

- Portabici posteriore per il trasporto di 2 biciclette/bici elettriche, realizzato per vetture con cofano o portellone standard/suv/van così come per vetture con spoiler, lunotti di vetro o paraurti in plastica (v. Application List in www.fabbri.info)
- Richiudibile quando viaggia a vuoto
- Pomello antifurto con chiavi disponibile tra gli optional
- Leggerezza e robustezza del prodotto garantite grazie all'utilizzo dell'alluminio elettrosaldato
- Montaggio delle biciclette mediante bracci in alluminio rotanti di 360°
- Con sistema "Viti Block" per la protezione dell'alluminio nel serraggio delle viti
- Con 6 snodi dentellati in ABS con doppio raggio per una perfetta tenuta anche su dossi stradali e strade sterrate
- Con 6 fibbie e 6 cinghie per il fissaggio su auto con ganci plastificati antigraffio (incl. Adapter)
- Con cinghiette e fibbiette robuste spessorati in gomma antigraffio per fissaggio ruote bici
- Canalina MTB di lunghezza 1250 mm munita di cinghiette ad inserto rapido per il fissaggio delle ruote, per ruote con passo fino a 1150 mm
- Cavetto di fissaggio del telaio in dotazione di 320 mm, per diametro ϕ 30-50 mm
- Non copre la targa
- Portata massima 45 Kg
- Conforme alla Normativa DIN 75302

BICI TORBOLINO

ALU BICI TORBOLINO

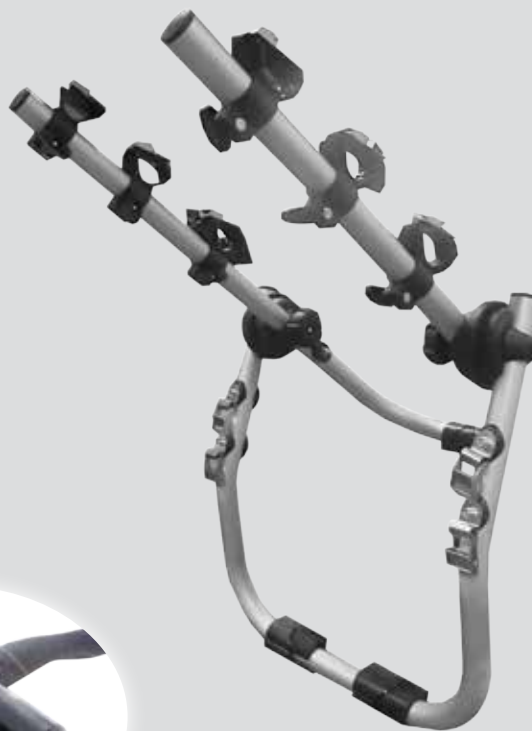

Adapter

ALUMINIUM!

PRE-ASSEMBLED // ARC-WELDED ALUMINIUM
PREMONTADO // ALUMINIO ELECTROSOLDADO
PREMONTATO // ALLUMINIO ELETTRSOLDATO

	Art. N°				ALU	Fe		
Bici Torbolino 3	6201809	✓	3	-	-	✓	Kg 4	1
Alu Bici Torbolino 3	6201808	✓	3	-	✓	-	Kg 3	1



OPTIONAL
Bici donna - uomo

	Art. N°		
Optional Bici Donna-Uomo	6201804	Kg 0,6	1

ALU BICI TORBOLE

ALUMINIUM!



PRE-ASSEMBLED // ARC-WELDED ALUMINIUM
PREMONTADO // ALUMINIO ELECTROSOLDADO
PREMONTATO // ALLUMINIO ELETTRISALDATO

	Art. N°					
Alu Bici Torbole 3	6201806	✓	3	-	Kg 6,2	1



OPTIONAL
Bici donna - uomo

	Art. N°		
Optional Bici Donna-Uomo	6201804	Kg 0,6	1





2 YEARS WARRANTY

BICI TORBOLE





Adapter

PRACTICAL & SAFETY
PRÁCTICO & SEGURO
PRATICO E SICURO

	Art. N°					
Bici Torbole 3 incl. Adapter	6201803	✓	3	–	Kg 6,3	1



OPTIONAL Bici donna - uomo

	Art. N°		
Optional Bici Donna-Uomo	6201804	Kg 0,6	1



GB REAR BIKES RACK FOR THE TRANSPORT OF 2 OR 3 BIKES

- Collection Bici Torbole incl. Adapter : is made for vehicles with standard hood or hatchback door or even if the car has a spoiler, the rear window is without frame (only glass) or the baggage car is made out of plastic (see Application List in www.fabbri.info)
- Made of particularly solid steel, silver painted with rust preventer treatment = absolute safety warranty even under extreme situations
- Thanks to the arc-welded tube the aluminium version has stronger features and it's even lighter
- With 4 double spoke notched joints for a perfect holding on hatch back and earth roads.
- With 4 double spoke notched joints for a perfect holding on cat's backs and earth roads.
- Mounting with 6 buckles and 6 belts with high quality scratch resistant plasticized hooks or with Adapter
- Foldable when removed from the car
- It does not cover the number plate that means it's not necessary to buy a second number plate support
- "Optional Bici Donna-Uomo ": adapter that allows to transport also women's bicycles (= bikes without crossbar)

ES PORTABICICLETAS TRASERO PARA EL TRANSPORTE DE 2 O 3 BICICLETAS

- Series Bici Torbole incl. Adaptador: ha sido fabricada para vehículos con maletero o puerta trasera estándar, también en caso de vehículo con spoiler, portón con cristal trasero sin marco, paragolpe de plástico (consulte Application List in www.fabbri.info)
- Fabricado en acero especialmente resistente, barnizado silver con tratamiento antioxidante = garantía de una absoluta seguridad incluso en situaciones extremas
- La versión en aluminio, además de gran robustez gracias al tubo electrosoldado, confiere una mayor ligereza.
- Con 4 articulaciones dentadas en ABS con doble radio para un perfecto cierre incluso en cambios de rasante y carreteras sin asfaltar
- Montaje con 6 hebillas y 6 correas con ganchos plastificados de alta calidad antirayado o con Adaptador
- Cerrable cuando desmontado
- No cubre la placa de la matrícula, por tanto, no es necesario comprar otra placa de la matrícula
- "Optional Bici Donna-Uomo" opcional: adaptador que permite transportar también las bicicletas de mujer (= bici sin barra)

IT PORTABICI POSTERIORE PER IL TRASPORTO DI 2 O 3 BICICLETTE

- Series Bici Torbole incl. Adapter: realizzato per vetture con cofano o portellone standard così come per vetture con spoiler, lunotti di vetro o paraurti in plastica (v. Application List in www.fabbri.info)
- Realizzato in acciaio particolarmente robusto, verniciato silver con trattamento antiruggine = garanzia di un'assoluta sicurezza anche in situazioni estreme
- La versione in alluminio, oltre alle caratteristiche di robustezza, grazie al tubo elettrosaldato beneficia anche di maggior leggerezza
- Con 4 snodi dentellati in ABS con doppio raggio per una perfetta tenuta anche su dossi stradali e strade sterrate
- Con 6 fibbie e 6 cinghie con ganci plastificati di alta qualità antigraffio o con Adapter
- Richiudibile quando smontato
- Non copre la targa, non è quindi necessario l'acquisto di una targa ripetitrice
- "Optional Bici Donna-Uomo": adattatore che permette di trasportare anche le biciclette da donna (bici senza canna)

+ 2 YEARS WARRANTY

GRINGO BICI

GRINGO SKI



ALUMINIUM!



ARC-WELDED ALUMINIUM // ALUMINIO ELECTROSOLDADO // ALLUMINIO ELETTRISALDATO



Art. N°					
6950251	2	✓	Kg 10	1	Ø 30 - 50 mm



Art. N°	
6950250	4

* OPTIONAL EXTENSION

	Art. N°	
	6950270	250 mm
	6950271	300 mm
	6950272	400 mm

OPTIONAL GRINGO BICI

	Art. N°				
	6950252	2	✓	Kg 6,5	1

OPTIONAL GRINGO SKI

	Art. N°						
	6950253	4	4	4	✓	Kg 8,5	1

UNIVERSAL
SYSTEM
PATENTED

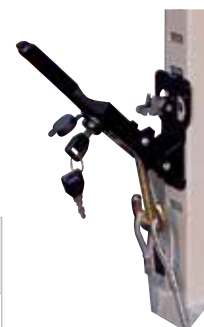

** OPTIONAL DISTANZIALE GRINGO SKI & BOARD

	Art. N°	
	6950267	1

OPTIONAL GRINGO SKI & BOARD

	Art. N°							
	6950259	6	6	6	4*	✓	Kg 4,2	1

GRINGO

SKI & BOARD



ARC-WELDED ALUMINIUM // ALUMINIO ELECTROSOLDADO // ALLUMINIO ELETTRISALDATO

	4	4	✓	Kg 10,5	1



Art. N°						
6950258	6	4	3 + 2	✓	Kg 8,2	1

GB GRINGO: NO NEED TO CHANGE IT, JUST TRANSFORM IT!

- Universal rear bicycle, ski and snowboard carriers for all off-road vehicles with rear spare wheel
- UNIVERSAL – it is fitted on all the rear spare wheels of off-road vehicles by means of the patented system "Universal System" with plastic-coated stainless steel cables
- Lightness and robustness of the product guaranteed thanks to the use of arc-welded aluminium
- Fast assembly on spare wheels of all sizes without the use of tools thanks to the variable quick-lever locking system
- Integration with the optional licence plate holder and lighting system separately available
- Gringo Bici: Rail length 1200 mm, for wheels with a width up to 51 mm and wheel base up to 1100 mm
- Preassembled
- Corresponding to rule ISO/PAS 11154:2006 Paragraph 5.3.4 Directive EEC 79/4888

* IMPORTANT : integration of the fixing cable to the spare wheel with the optional extension in three sizes to be considered at the time of purchase

**In the case of carriage of snowboards it is necessary the purchase of the spacer reference 6950267

ES GRINGO: ¡NO LO CAMBIAS, LO TRANSFORMAS!

- Portabicicletas, portaesquís y snow-board para todos los vehículos todoterreno con rueda de repuesto trasera
- UNIVERSAL - se monta sobre todas las ruedas de repuesto traseras del todoterreno mediante el sistema patentado "Universal System" con cables de acero inoxidable revestidos de plástico
- El uso de aluminio electrosoldado garantiza ligereza y robustez del producto
- Montaje rápido sin herramientas gracias al sistema de cierre de palanca rápida variable a las ruedas de repuesto de todas las dimensiones
- Portaplaca e iluminación opcionales disponibles, vendidos a parte
- Gringo Bici: largo de la vía 1200 mm, para ruedas de hasta 51 mm de ancho y de 1100 mm de paso
- Premontado, listo para usar
- Conforme a la norma ISO/ PAS 11154:2006 Apartado 5.3.4. Directiva CEE 79/488

* IMPORTANTE: es posible complementar el cable de fijación a la rueda de repuesto trasera con prolongación opcional en 3 medidas diferentes, se valorará en el momento de la compra

**En el caso del transporte snowboard requiere la compra de un código espaciador opcional 6950267

IT GRINGO: NON LO CAMBI, LO TRASFORMI!

- Portabici, portasci e snow-board posteriori universali per tutti i fuoristrada con ruota di scorta posteriore
- UNIVERSALE – si monta su tutte le ruote di scorta posteriore del fuoristrada tramite il sistema brevettato "Universal System" con cavi in acciaio Inox rivestiti in plastica
- Leggerezza e robustezza del prodotto garantite grazie all'utilizzo dell'alluminio elettrosaldato
- Montaggio rapido senza l'ausilio di attrezzi grazie al sistema di chiusura a leva rapida variabile alle ruote di scorta di tutte le dimensioni
- Integrazione con Optional porta targa e fanaleria disponibili a parte
- Gringo Bici: Lunghezza del binario 1200 mm, per ruote con larghezza fino a 51 mm e passo fino a 1100 mm
- Preassemblato
- Conforme alla norma ISO/ PAS 11154:2006 Paragraph 5.3.4. Direttiva CEE 79/488

* IMPORTANTE: integrabilità del cavo di fissaggio alla ruota di scorta con l'optional proluga in 3 misure, da valutare al momento dell'acquisto

**In caso di trasporto snowboard è necessario l'acquisto dell'optional distanziale codice 6950267

PATENTED

CITY CRASH TEST

2 YEARS WARRANTY

BICI 1000



	Art. N°						
Bici 1000	6201343	1	Max 53 mm	-	Max 40x60 mm	Kg 3	1

GB

- Bike rack for all bars up to max. 40x60 mm section
- Bikes rack with black dust painted profiles and steel tubes, suitable for any kind of bike with frames up to Ø 53 mm
- With 2 solid belts and buckles of shimmed scratch resistant rubber for fastening of bike wheels
- Rail's length : min 1390 mm up to 1420 mm, for wheels with a width up to 51 mm & wheel base up to 1320 mm • Corresponding to rule ISO/PAS 11154:2006 Paragraph 5.3.4./Directive EEC 79/488

ES

- Portabicicletas para todas las barras de hasta una sección max. de 40x60 mm
- Portabicicletas con perfiles y tubos de acero barnizado con polvo de color negro, adaptables a todos los tipos de bicicletas con cuadros de hasta Ø 53 mm
- Con 2 correas y hebillas resistentes engrosadas con goma antirayado para la fijación de las ruedas de la bici
- Largo de la vía: de 1390 mm a 1420 mm, para ruedas de hasta 51 mm de ancho y de hasta 1320 mm de paso
- Conforme a la norma ISO/ PAS 11154:2006 Apartado 5.3.4./Directiva CEE 79/488

IT

- Portabici per tutte le barre fino a sezione max. di 40x60 mm
- Portabici con profili e tubi in acciaio verniciato a polvere nero, adattabile a tutti i tipi di biciclette con telai fino Ø 53 mm
- Cinturini bloccaggio ruota con protezione in gomma per massima protezione dei pneumatici.
- Lunghezza del binario: min 1390 mm a 1420 mm, per ruote con larghezza fino a 51 mm e passo fino a 1320
- Conforme alla norma ISO/PAS 11154:2006 Paragraph 5.3.4./Direttiva CEE 79/488

BICI 2000 ALU



	Art. N°							
Bici 2000 Alu	6201339	1	Max 53 mm	✓	Max 40x40 mm	22x6.5 mm	Kg 2,6	1

GB

- Bicycle rack that can be assembled on all bars with a maximum section up to 40x40 mm and on most aluminium bars with groove
- With Optional Canalina, reference 6201336, for bars with max dimension 60 mm
- Preamsembled bicycle rack with antitheft
- In aluminium and galvanized and painted steel
- Suitable for any kind of bike with frames up to Ø 53 mm
- Rail's length : min 1480, for wheels with a width up to 51 mm & wheel base up to 1380 mm
- With 2 solid belts and buckles of shimmed scratch resistant rubber for fastening bike wheels
- Corresponding to rule ISO/PAS 11154:2006 Paragraph 5.3.4./Directive EEC 79/488

ES

- Portabicicletas que se puede montar en todas las barras con sección. max. de hasta 40 x 40 y en la mayor parte de las barras de aluminio con conducto
- Con adaptador opcional 6201336 para barras de dim. max. 60 mm
- Portabicicletas premontado con antirrobo
- Con perfiles en aluminium y tubos de acero barnizado
- Adaptables a cualquier tipo de bicicleta con cuadros hasta Ø 53 mm
- Largo de la vía: de 1480 mm, para ruedas de hasta 51 mm de ancho y de hasta 1380 mm de paso
- Con 2 correas y hebillas resistentes engrosadas con goma antirayado para la fijación de las ruedas de la bici
- Conforme a la norma ISO/ PAS 11154:2006 Apartado 5.3.4./Directiva CEE 79/488

IT

- Portabici montabile su tutte le barre con sezione max. fino a 40x40 mm e per la maggior parte delle barre in alluminio con canalina
- Con Optional cod.6201336 per barre dim. Max 60mm
- Portabiciclette premontato con antifurto
- In alluminio e acciaio zincato e verniciato
- Adattabile a tutti i tipi di bicicletta con telai fino a Ø 53 mm
- Lunghezza del binario: 1480 mm, per ruote con larghezza fino a 51 mm e passo fino a 1380
- Con 2 cinghietti e fibbiette robuste spessorati in gomma antigraffio per fissaggio ruote bici
- Conforme alla norma ISO/PAS 11154:2006 Paragraph 5.3.4./Direttiva CEE 79/488



	Art. N°	
Adapter Bici 2000 Alu	6201336	Max 60 mm



BICI 3000 ALU

ALUMINIUM!



	Art. N°							
Bici 3000 Alu	6201341	1	30 - 75 mm	✓	Max 75x40 mm	22x6.5 mm	Kg 3,7	1

GB

- Bicycle rack with antitheft that can be assembled on all bars with a maximum section up to 75x40 mm and on most aluminium bars with groove
- Preassembled bicycle rack
- In aluminium and galvanized and painted steel
- Suitable for any kind of bike with frames from Ø 30 to Ø 75
- Rail's length : min 1480, for wheels with a width up to 51 mm & wheel base up to 1380 mm
- With 2 solid belts and buckles of shimmed scratch resistant rubber for the fastening of the bike wheels
- Corresponding to rule DIN 75302

ES

- Portabicicletas con antirrobo que se puede montar en todas las barras con sección. max. de hasta 75x40 y en la mayor parte de las barras de aluminio con conducto
- Portabicicletas premontado
- Con perfiles en aluminio y tubos de acero barnizado
- Adaptables a cualquier tipo de bicicleta con cuadros de 30 hasta Ø 75 mm
- Largo de la vía: de 1480 mm, para ruedas de hasta 51 mm de ancho y de hasta 1380 mm de paso
- Con 2 correas y hebillas resistentes engrosadas con goma antirayado para la fijación de las ruedas de la bici
- Conforme a la Norma DIN 75302

IT

- Portabici con antifurto montabile su tutte le barre con sezione max. fino a 75x40 mm e per la maggior parte delle barre in alluminio con canalina
- Completamente assemblato, pronto per l'uso
- In alluminio e acciaio zincato e verniciato
- Adattabile a tutti i tipi di bici con telai fino da Ø 30 a Ø 75 mm
- Lunghezza del binario: 1480 mm, per ruote con larghezza fino a 51 mm e passo fino a 1380
- Con 2 cinghietti e fibbiette robuste spessorati in gomma antigraffio per fissaggio ruote bici
- Conforme alla Normativa DIN 75302

BICI 3000 ALU NEW

ALUMINIUM!



	Art. N°							
Bici 3000 Alu New	6201342	1	30 - 75 mm	✓	Max 75x40 mm	22x6.5 mm	Kg 3,7	1

GB

- Bicycle rack with antitheft that can be assembled on all bars with a maximum section up to 75x40 and on most aluminium bars with groove
- Suitable for all kind of bike with frames from Ø 30 to Ø 75 mm
- MTB rail 1450 mm long fitted with quick-insert strap for fixing the wheels with wheelbase up to 1350 mm
- Corresponding to rule DIN 75302

ES

- Portabicicletas con antirrobo, montable sobre cualquier barra hasta sección máxima de 75x40 mm y para la mayoría de barras en aluminio con canaleta
- Adaptable a todo tipo de bicicletas con cuadros de Ø 30 a Ø 75 mm
- Canales MTB de 1450 mm de largo con correa a inserción rápida para la fijación de las ruedas con paso de hasta 1350 mm
- Conforme a la Norma DIN 75302

IT

- Portabici con antifurto montabile su tutte le barre con sezione max. fino a 75x40 mm e per la maggior parte delle barre in alluminio con canalina
- Adattabile a tutti i tipi di bici con telai fino da Ø 30 a Ø 75 mm
- Canaline MTB di lunghezza 1450 mm munite di cinghietta ad inserto rapido per il fissaggio delle ruote con passo fino a 1350 mm
- Conforme alla Normativa DIN 75302



+ 2 YEARS WARRANTY

+ PATENTED

BICI OK 3 CAMPER BASE LUNGO

BICI OK 3 CAMPER BASE CORTO

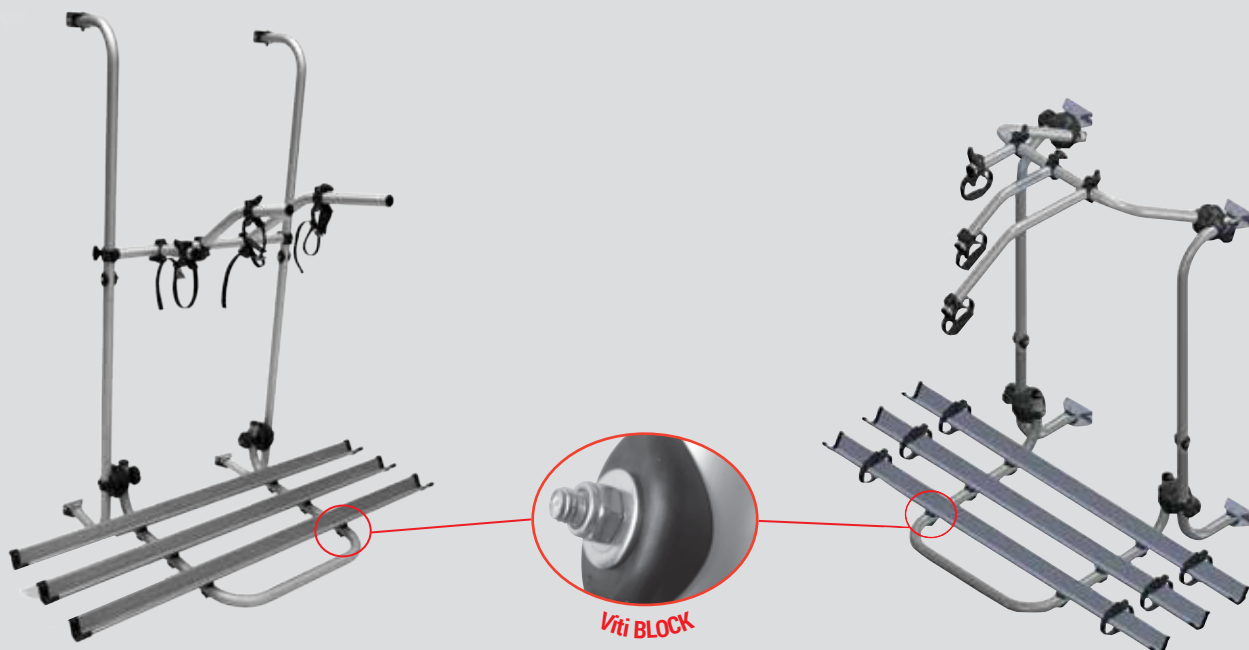

ARC-WELDED ALUMINIUM // ALUMINIO ELECTROSOLDADO // ALLUMINIO ELETTRISALDATO

	Art. N°						H Telaio H Frame
Bici Ok 3 Camper Base Lungo	6201832	—	3	—	Kg 7,6	1	Min 95 cm Max 140 cm
Bici Ok 3 Camper Base Corto	6201834	—	3	—	Kg 7,6	1	Min 47 cm Max 87 cm

OPTIONAL CANALINA MTB

	Art. N°		
Optional Canalina MTB	6201863	Kg 1	1

OPTIONAL Bici donna - uomo

	Art. N°		
Optional Bici Donna-Uomo	6201804	Kg 0,6	1



GB

- Rear Bike carrier made of anodized aluminium for camping van
- Supports to the car made of scratch resistant anti stain rubber
- Double spoke notched joints made of thermoplastic material with high mechanical resistance
- Buckles for fixing belts and stainless steel rails fitted through anti-vibration thickness (Viti Block)
- Not pre-assembled
- Corresponding to rule DIN 75302

ES

- Portabicicletas trasero de aluminio anodizado para autocaravana
- Apoyos al vehículo en goma antiarañazos y antimanchas
- Juntas de material termoplástico de alta resistencia mecánica
- Canales de acero y hebillas para las cintas provistos de tacos antivibratorios (Viti Block)
- Se entrega en desmontado
- De acuerdo con la norma DIN 75302

IT

- Portabiciclette posteriore in alluminio anodizzato per camper
- Appoggi a vettura in gomma antigraffio e antimacchia
- Snodi in materiale termoplastico ad elevata resistenza meccanica
- Canaline in acciaio e fibbie per cinghie montate tramite tasselli antivibranti (Viti Block)
- Fornito smontato
- Conforme alla Normativa DIN 75302

BICI OK 3 CAMPER TOP LUNGO

BICI OK 3 CAMPER TOP CORTO



ARC-WELDED ALUMINIUM // ALUMINIO ELECTROSOLDADO // ALLUMINIO ELETTRISALDATO

	Art. N°						H Telaio H Frame
Bici Ok 3 Camper Top Lungo	6201833	–	3	–	Kg 9	1	Min 95 cm Max 140 cm
Bici Ok 3 Camper Top Corto	6201835	–	3	–	Kg 9	1	Min 47 cm Max 87 cm



OPTIONAL CANALINA MTB

	Art. N°		
Optional Canalina MTB	6201863	Kg 1	1



OPTIONAL Bici donna - uomo

	Art. N°		
Optional Bici Donna-Uomo	6201804	Kg 0,6	1

GB

- Rear Bike carrier made of anodized aluminium for camping van, with anti-theft
- Supports to the car made of scratch resistant anti stain rubber
- Double spoke notched joints made of thermoplastic material with high mechanical resistance
- Buckles for fixing belts and stainless steel rails fitted through anti-vibration thickness (Viti Block)
- Not pre-assembled
- Corresponding to rule DIN 75302

ES

- Las portabicicletas trasero de aluminio anodizado para autocaravana, con antirrobo
- Apoyos al vehículo en goma antiarañazos y antimanchas
- Juntas de material termoplástico de alta resistencia mecánica
- Canales de acero y hebillas para las cintas provistos de tacos antivibratorios
- Se entrega en desmontado
- De acuerdo con la norma DIN 75302

IT

- Portabiciclette posteriore in alluminio anodizzato per camper, con antifurto
- Appoggi a vettura in gomma antigraffio e antimacchia
- Snodi in materiale termoplastico ad elevata resistenza meccanica
- Canaline in alluminio e fibbie per cinghie montate tramite tasselli antivibranti
- Fornito smontato
- Conforme alla Normativa DIN 75302

+ 2 YEARS WARRANTY

RELING UNIVERSALE BASE



GB





- Pair of universal steel or alu bars with supports adjustable in width
- Steel profile completely galvanised covered with atoxic PVC
- Alu galvanised profile with groove to mount accessories (measures 22x6,5 mm) with real high quality anti-slip rubber profile
- Well fastened plastic end caps
- Fixing through steel screws and anti-slip rubber support
- Maximum load: 50 Kg
- Corresponding to rule DIN 75302

ES

- Barras de techo universales para reling en acero o en aluminio con apoyos regulables en anchura
- Barras en acero totalmente cincado y revestidas con PVC atóxico
- Barras en aluminio anodizado con canal para el montaje de varios accesorios - dimensión 22x6,5mm - con perfil de protección de auténtica goma antideslizada
- Tapones terminales bien anclados en termoplásticos
- Fijación para tornillos en acero y apoyos de auténtica goma antirayada
- Carga máxima total: 50 Kg
- Conforme a la Norma DIN 75302





IT

- Coppia barre reling universali in acciaio e in alluminio con appoggi regolabili in larghezza
- Profilo barra in acciaio totalmente zincato con rivestimento in PVC atossico
- Profilo barra in alluminio anodizzato con canalina superiore per applicazione accessori misure 22x6,5mm con profilo di protezione superiore in vera gomma antiscivolo
- Tappi fine corsa in termoplastica ben ancorati
- Fissaggio tramite viti in acciaio e appoggio in gomma antigraffio
- Portata massima complessiva 50 Kg.
- Conforme alla Normativa DIN 75302

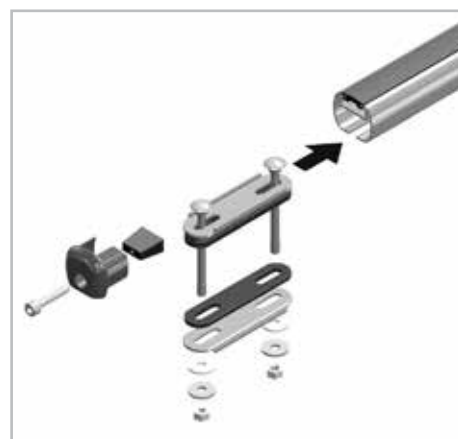
	Art. N°	↔		Fe			
Reling Universale Base	6201560	1220 mm	30 x 20 mm	✓	—	Kg 3	1
	6201561	1350 mm	30 x 20 mm	✓	—	Kg 2,6	1





ALU RELING UNIVERSALE BASE



	Art. N°	↔		ALU			
Alu Reling Universale Base	6201570	1220 mm	35 x 30 mm	✓	—	Kg 1,7	1
	6201571	1350 mm	35 x 30 mm	✓	—	Kg 1,9	1





RELING UNIVERSALE BARRO



	Art. N°	↔		Fe			
Reling Universale Barro	6201580	1220 mm	30 x 35 mm	✓	–	Kg 4	1
	6201581	1350 mm	30 x 35 mm	✓	–	Kg 4,4	1

ALU RELING UNIVERSALE BARRO



	Art. N°	↔		ALU			
Alu Reling Universale Barro	6201590	1220 mm	30 x 35 mm	✓	–	Kg 2,9	1
	6201591	1350 mm	30 x 35 mm	✓	–	Kg 3,2	1

GB

- Multipurpose universal bars for all kind of reling particularly suitable for heavy load transport
- Steel profile completely galvanised covered with atoxic PVC
- Alu galvanised profile with groove to mount accessories (measures 27x5 mm) with real high quality anti-slip rubber profile
- Well fastened plastic end caps
- Fixing through steel screws and anti-slip rubber support
- Maximum load: 75 Kg
- Corresponding to rule DIN 75302

ES

- Portatodo universal para todos los tipos de reling America y particularmente realizado para los vehículos comerciales
- Barras en acero totalmente cincado y revestidas con PVC atóxico
- Barras en aluminio anodizado con canal para el montaje de varios accesorios - dimensión 27x5mm con perfil de protección de PVC antideslizado
- Tapones terminales bien anclados en termoplásticos
- Sistema de fijación para tornillos en acero y apoyos de auténtica goma antirayada
- Carga máxima total: 75 Kg
- Conforme a la Norma DIN 75302

IT

- Portatutto universale per tutti i tipi di reling america e particolarmente indicato per carichi pesanti
- Profilo barra in acciaio totalmente zincato con rivestimento in PVC atossico
- Profilo barra in alluminio anodizzato con canalina superiore per applicazione accessori misure 27x5mm con profilo di protezione superiore in PVC antiscivolo
- Tappi fine corsa in termoplastica ben ancorati
- Fissaggio tramite viti in acciaio e appoggio in gomma antigraffio
- Portata massima complessiva 75 Kg.
- Conforme alla Normativa DIN 75302

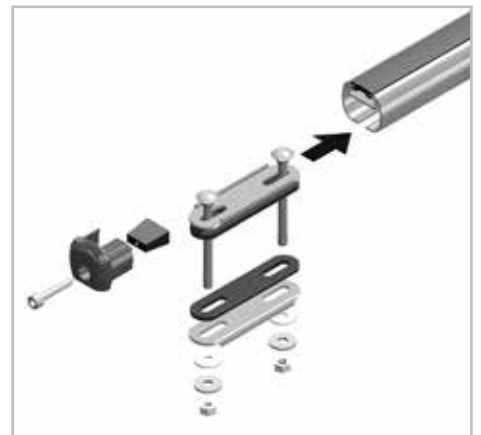

RELING UNIVERSALE



ULTRA RAPID MOUNTING // MONTAJE // MONTAGGIO

	Art. N°	↔				
Reling Universale	6201500	116 cm	30 x 20 mm	✓	Kg 3,3	1
	6201501	127 cm	30 x 20 mm	✓	Kg 3,6	1
Opt. Cavetti	6201530	mm 400				
	6201531	mm 490				

GB

- Multipurpose bars for any kind of railing (American bars) due to the hooking system with double stainless steel coated cables and real rubber bearings for a perfect holding and grip on the longitudinal bars of any size
- Particularly tough steel bars, adjustable in width, internal and external galvanized and atoxic PVC coated with well fastened end caps
- Easy assembly and disassembly due to the ultra-rapid coupling
- Preassembled
- Antitheft for the fitting and the bars
- Capacity: 75 kg.
- Corresponding to rule ISO/PAS 11154:2006 Paragraph 5.3.4./Directive EEC 79/4888

ES

- Portatodo para todos los tipos de reling (barras universales), gracias al sistema de enganche con dobles cables de acero inoxidable revestidos y apoyos de auténtica goma par un perfecto cierre y adherencia a las barras longitudinales de cualquier forma
- Barras regulables en anchura, en acero cincado tanto en el interior como el exterior y revestido con PVC atóxico
- Facil montaje y desmontaje gracias al enganche Ultrarrapido
- Capacidad: 75 Kg.
- Antirrobo para el enganche y las barras
- Premontado
- Conforme a la norma ISO/ PAS 11154:2006 Apartado 5.3.4./Directiva CEE 79/488

IT

- Portatutto universale per tutti i tipi di Reling (barre America) grazie al sistema di aggancio con doppi cavi in acciaio Inox rivestiti e appoggi in vera gomma per una perfetta tenuta ed aderenza alle barre longitudinali di qualsiasi forma
- Barre in acciaio particolarmente robusto, zincate internamente ed esternamente e rivestite in PVC atossico con tappi terminali ben ancorati
- Facile montaggio e smontaggio grazie all'attacco ultrarapido
- Portata: 75 Kg.
- Antifurto
- Premontato
- Conforme alla norma ISO/PAS 11154:2006 Paragraph 5.3.4./Direttiva CEE 79/488

ALU RELING UNIVERSALE



ULTRA RAPID MOUNTING // MONTAJE // MONTAGGIO

	Art. N°	↔		
Alu Reling Universale	6201520	116 cm		
	6201521	127 cm		
Opt. Cavetti	6201530	mm 400		
	6201531	mm 490		

GB

- Multipurpose bars for any kind of railing (American bars) due to the hooking system with double stainless steel coated cables and real rubber bearings for a perfect holding and grip on the longitudinal bars of any size
- Particularly tough aluminium bars with width adjustable fittings and well fastened antitheft end caps.
- With real rubber profile, easily extractable and insertable for

ES

- Portatodo para todos los tipos de reling (barras universales), gracias al sistema de enganche con dobles cables de acero inoxidable revestidos y apoyos de auténtica goma par un perfecto cierre y adherencia a las barras longitudinales de cualquier forma
- Barras de aluminio especialmente resistente con enganches ajustables en anchura con tapones terminales bien anclados y antirrobo

IT

- Portatutto universale per tutti i tipi di Reling (barre America) grazie al sistema di aggancio con doppi cavi in acciaio Inox rivestiti e appoggi in vera gomma per una perfetta tenuta ed aderenza alle barre longitudinali di qualsiasi forma
- Barre in alluminio particolarmente robusto con attacchi regolabili in larghezza con tappi terminali ben ancorati e antifurto
- Con profilo in vera gomma facilmente estraibile ed inseribile



VIVA BASE



TAJE // MONTAGGIO



ULTRA RAPID MOUNTING // MONTAJE // MONTAGGIO

35 x 30 mm	✓	✓	Kg 3,2	1
35 x 30 mm	✓	✓	Kg 3,5	1

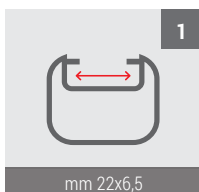

	Art. N°	↔				
Viva Base	12DW8500	825 - 1240 mm	30 x 20 mm	✓	Kg 3,8	1

- the assembly of different accessories in the groove (1)
- Preamsembled
 - Antitheft for the fitting and the bars
 - Capacity : 75 kg.
 - Corresponding to rule ISO/PAS 11154:2006 Paragraph 5.3.4./Directive EEC 79/4888

- Con perfil de auténtica goma fácilmente extraíble e insertable para el montaje de varios accesorios en el canal (1)
- Capacidad: 75 Kg.
- Antirrobo para el enganche y las barras
- Premontado
- Conforme a la norma ISO/ PAS 11154:2006 Apartado 5.3.4./ Directiva CEE 79/488

- per il montaggio di vari accessori nella canalina (1)
- Portata: 75 Kg.
 - Antifurto per l'attacco e le barre
 - Premontato
 - Conforme alla norma ISO/PAS 11154:2006 Paragraph 5.3.4./ Drettiva CEE 79/488

GB

- Pair of universal extensible steel bars for reling
- Steel profile completely galvanised covered with atoxic pvc
- Painted steel fixation with scratch resistant and anti-slip support
- Fixing set to reling bars through double covered cables made of inox steel
- Capacity: 50 Kg
- Antitheft
- Pair of bars supplied in carton box
- Corresponding to rule DIN 75302

ES

- Barras de techo extensibles en acero para reling
- Barra en acero totalmente cincado y revestidas con PVC atóxico
- Pie en acero barnizado y apoyo de auténtica goma antirayada y antideslizada
- Sistema de enganche a la barra America con dobles cables de acero inoxidable revestidos
- Capacidad : 50 Kg
- Antirrobo
- Confección: caja individual por cada par de barras
- Conforme a la Norma DIN 75302

IT

- Coppia barre estensibili in acciaio per reling da tetto
- Profilo barra in acciaio totalmente zincato rivestite in PVC atossico
- Piede in acciaio verniciato con appoggio in gomma antigraffio e antiscivolo
- Sistema di aggancio al reling america tramite doppi cavi in acciaio inox rivestiti
- Portata: 50 Kg.
- Antifurto
- Imballo in scatola singola per coppia di barre
- Conforme alla Normativa DIN 75302

+ 2 YEARS WARRANTY

ALU VIVA 2

BLACK / SILVER



RELING STANDARD

	Art. N°	↔		ALU			
Alu Viva 2 Black	12AW6800	85 - 122 cm	42 x 28 mm	✓	✓	Kg 3,6	1
Alu Viva 2 Silver	12AW6600	85 - 122 cm	42 x 28 mm	✓	✓	Kg 3,4	1

GB

- Quick and easy fitting to every section of the longitudinal bars
- With straps and regulation jack anchorage
- Antitheft
- Bars 40x28 mm
- Preassembled
- Maximum load: 75 kg.
- Corresponding to rule DIN 75302

ES

- Montaje rápido y cómodo en cualquier tipo de sección de barra longitudinal
- Anclaje mediante correa y martinete de regulación
- Con sistema antirrobo
- Barras 40x28 mm
- Premontado
- Carga máxima: 75 Kg.
- Conforme a la Norma DIN 75302

IT

- Montaggio rapido e comodo su ogni tipo di sezione di barra longitudinale
- Ancoraggio tramite cinghietti e martinetto di regolazione
- Antifurto
- Barra 40x28 mm
- Premontato
- Portata complessiva: Kg.75
- Conforme alla Normativa DIN 75302

ALU VIVA 2

INTEGRATO BLACK / SILVER

ALUMINIUM!

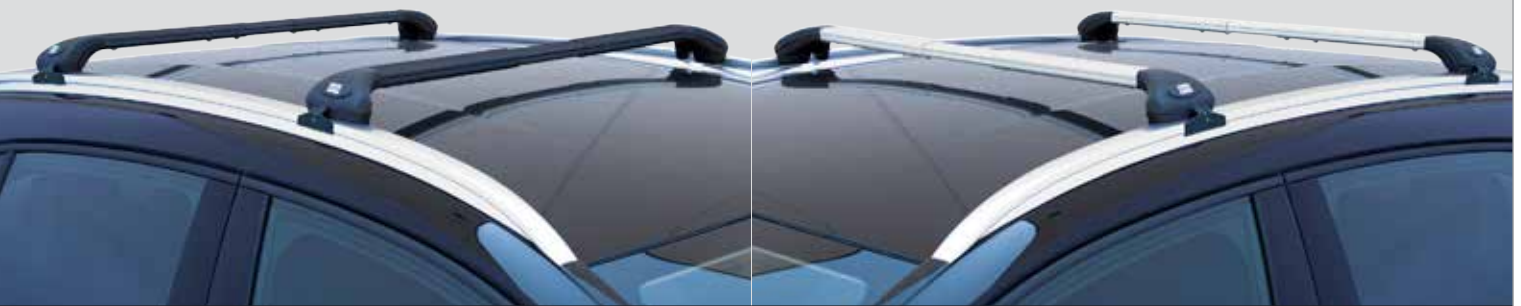

RELING INTEGRATED // INTEGRADO // INTEGRATO

	Art. N°	↔		ALU			
Alu Viva 2 Integrato Black	12AW6900	85 - 122 cm	42 x 28 mm	✓	✓	Kg 3,2	1
Alu Viva 2 Integrato Silver	12AW6700	85 - 122 cm	42 x 28 mm	✓	✓	Kg 3,0	1



OPTIONAL KIT STAFFE

	Art. N°
Kit Viva 2 Integrato (4 PZ.)	6201600

GB

- Quick and easy fitting to every section of the longitudinal bars
- Anchorage through strengthened brackets
- Antitheft
- Made of particularly tough aluminium bars
- Bars 40x28 mm
- Preassembled
- Maximum load: 75 kg
- Corresponding to rule DIN 75302

ES

- Montaje rápido y cómodo en cualquier tipo de sección de barra longitudinal
- Anclaje con soportes reforzados
- Con sistema antirrobo
- De aluminio
- Barras 40x28 mm
- Premontado
- Carga máxima: 75 Kg
- Conforme a la Norma DIN 75302

IT

- Montaggio rapido e comodo su ogni tipo di sezione di barra longitudinale
- Ancoraggio tramite staffe rinforzate
- Antifurto
- Materiale: alluminio particolarmente robusto
- Barra 40x28 mm
- Premontato
- Portata complessiva: 75 Kg
- Conforme alla Normativa DIN 75302

+ 2 YEARS WARRANTY





TOP ROAD PER MANCORRENTI

ALUMINIUM!

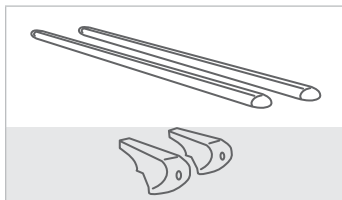

ULTRA RAPID MONTAGE // MONTAGE // MONTAGGIO



	Art. N°	↔				
Barre Top Road Set Pz.2	6501001	1080 mm	54 x 28 mm	-	Kg 2,1	1
	6501002	1200 mm				
	6501003	1270 mm				
	6501004	1400 mm				
Piedi Top Road Manc. Set Pz.4	+ 6501101	-	-	✓	Kg 1,5	1

GB

- Quick and comfortable fitting
- Aerodynamic bars made of aluminium with groove to mount optional
- The feet are made of thermoplastic material with galvanized steel core
- Antitheft
- Maximum load : 100 kg.
- Corresponding to rule DIN 75302

ES

- Montaje rápido y fácil
- Barra aerodinámica en aluminio con canaleta para anclaje de accesorios
- Soporte en material termoplástico con alma en acero cincado
- Antirrobo
- Carga máxima: 100 Kg.
- Conforme a la Norma DIN 75302

IT

- Montaggio rapido e comodo
- Barra aerodinamica in alluminio con canalina per ancoraggio degli accessori
- Piedi in materiale termoplastico con anima in acciaio zincato
- Antifurto
- Portata complessiva: Kg.100
- Conforme alla Normativa DIN 75302

TOP ROAD

ALUMINIUM!



ULTRA RAPID MONTAGE // MONTAGE // MONTAGGIO

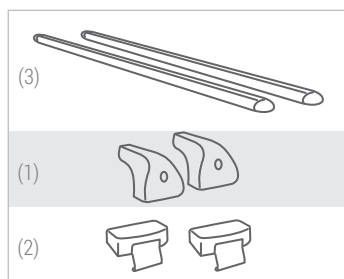

	Art. N°	↔				
Barre Top Road Set Pz.2	6501001 6501002 6501003 6501004	1080 mm 1200 mm 1270 mm 1400 mm	54 x28 mm	-	Kg 2,1 Kg 2,34 Kg 2,46 Kg 2,72	1
Piedi Top Road Set Pz.4	+ 6501201	-	-	✓	Kg 1,5	1
Kit Fissaggio Top Road	+ 6501XXX	-	-	-	Kg 0,6	1

Consultar tabla de aplicaciones en www.fabbri.info
See application list on www.fabbri.info
Consultare tabella applicazioni sul sito www.fabbri.info

GB

- Aerodynamic bars made of aluminium with groove to mount optional
- The feet are made of thermoplastic material
- Antitheft
- Maximum load: 50-75 kg.
- Corresponding to rule DIN 75302

(1) For kit without provided fixing points the maximum load is 50 Kg
(2)(3) See application list on www.fabbri.info

ES

- Barra aerodinámica en aluminio con canaleta para anclaje de accesorios
- Soporte en material termoplástico
- Antirrobo
- Carga máxima: 50-75 Kg.
- Conforme a la Norma DIN 75302

(1) Para Kit sin punto de fijación, carga máxima total 50 kg
(2)(3) Consultar tabla de aplicaciones en www.fabbri.info

IT

- Barra aerodinamica in alluminio con canalina per ancoraggio degli accessori
- Piedi in materiale termoplastico
- Antifurto
- Portata complessiva: Kg.50-75
- Conforme alla Normativa DIN 75302

(1) Per Kit senza punti di fissaggio, portata 50 kg max complessiva
(2)(3) Consultare tabella applicazioni sul sito www.fabbri.info

+ 2 YEARS WARRANTY

TOP ROAD 30x20



ULTRA RAPID MONTAGE // MONTAGE // MONTAGGIO

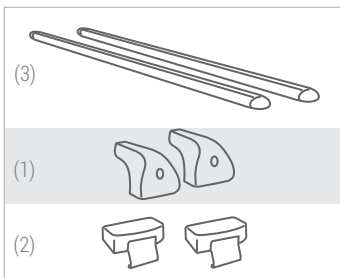

	Art. N°	↔				
Barre Top Road 30x20 Set Pz.2	6501005	1080 mm	30 x20 mm	-	Kg 1,3	1
	6501006	1200 mm				
	6501007	1270 mm				
	6501008	1400 mm				
Piedi Top Road Set Pz.4	+ 6501201	-	-	✓	Kg 1,5	1
Kit Fissaggio Top Road	+ 6501XXX	-	-	-	Kg 0,6	1

Consultar tabla de aplicaciones en www.fabbri.info
 See application list on www.fabbri.info
 Consultare tabella applicazioni sul sito www.fabbri.info

GB

- Quick and comfortable fitting
- Steel bars
- The feet are made of thermoplastic material with galvanized steel core
- Antitheft
- Maximum load :50-75 kg.
- Corresponding to rule DIN 75302

(1) For kit without provided fixing points the maximum load is 50 Kg

(2)(3) See application list on www.fabbri.info

ES

- Montaje rápido y fácil
- Barras en anchura
- Soporte en material termoplástico con alma en acero cincado
- Antirrobo
- Carga máxima: kg 50-75
- Conforme a la Norma DIN 75302

(1) Para Kit sin punto de fijación, carga máxima total 50 kg

(2)(3) Consultar tabla de aplicaciones en www.fabbri.info

IT

- Montaggio rapido e comodo
- Barra in acciaio a sezione rettangolare
- Piedi in materiale termoplastico con anima in acciaio zincato
- Antifurto
- Portata complessiva: Kg.50-75
- Conforme alla Normativa DIN 75302

(1) Per Kit senza punti di fissaggio, portata 50 kg max complessiva

(2)(3) Consultare tabella applicazioni sul sito www.fabbri.info

TOP ROAD BARRO



ULTRA RAPID MONTAGE // MONTAGE // MONTAGGIO

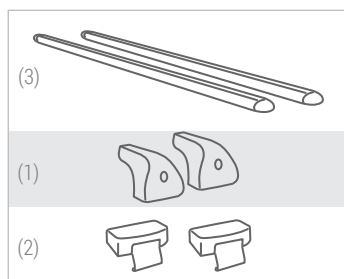

	Art. N°	↔				
Barre Top Road Barro Set Pz.2	6501009 6501010 6501011 6501012	1080 mm 1200 mm 1270 mm 1400 mm	30x35 mm	—	Kg 1,7 Kg 1,9 Kg 2 Kg 2,2	1
Piedi Top Road Set Pz.4	+ 6501201	—	—	✓	Kg 1,5	1
Kit Fissaggio Top Road	+ 6501XXX	—	—	—	Kg 0,6	1

Consultar tabla de aplicaciones en www.fabbri.info
See application list on www.fabbri.info
Consultare tabella applicazioni sul sito www.fabbri.info

GB

- Steel bars
- The feet are made of thermoplastic material
- Antitheft
- Maximum load: 50-75 kg.
- Corresponding to rule DIN 75302

(1) For kit without provided fixing points the maximum load is 50 Kg

(2)(3) See application list on www.fabbri.info

ES

- Barras regulables en anchura
- Soporte en material termoplástico
- Antirrobo
- Carga máxima: 50-75 Kg.
- Conforme a la Norma DIN 75302

(1) Para Kit sin punto de fijación, carga máxima total 50 kg

(2)(3) Consultar tabla de aplicaciones en www.fabbri.info

IT

- Barra in acciaio
- Piedi in materiale termoplastico
- Antifurto
- Portata complessiva: Kg.50-75
- Conforme alla Normativa DIN 75302

(1) Per Kit senza punti di fissaggio, portata 50 kg max complessiva

(2)(3) Consultare tabella applicazioni sul sito www.fabbri.info

+ 2 YEARS WARRANTY

ADAMANTIS

460 - 550



Slim lock



DUAL-SIDE // ABS SLIMLOCK PREASSEMBLED // PREMONTADO // PREMONTATO

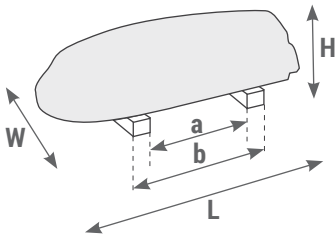

	Art. N°						L x W x H				Max Kg		a Min b Max
Adamantis 460	12A85300		6	6	✓	✓	cm 185x80x42	lt 460	Max 75x40 mm	Kg 17	Kg 75	1	Min 420 Max 1120
	12A85400		6	6	✓	✓	cm 185x80x42	lt 460	Max 75x40 mm	Kg 17	Kg 75	1	
	12A85200		6	6	✓	✓	cm 185x80x42	lt 460	Max 75x40 mm	Kg 17	Kg 75	1	
Adamantis 550	12A85500		7	7	✓	✓	cm 203x89x42	lt 550	Max 75x40 mm	Kg 20	Kg 75	1	Min 470 Max 1180

GB

- Made of high quality ABS with UV ray protection
- Box for those who requires only the the very best
- To transport large loads in the utmost comfort
- Elegant and exclusive lines harmonize perfectly with all the latest vehicles
- With dual-side opening system
- Available in two different capacities for more carrying requirements
- With 2 belts
- Corresponding to rule ISO/PAS 11154:2006 Paragraph 5.3.4./Directive EEC 79/488
- Patented design and locking system.

ES

- Fabricado en ABS de calidad con protección frente a los rayos UV
- Box para quien desea la gama más alta
- Para transportar volúmenes importantes de modo confortable
- Sus líneas elegantes y exclusivas armonizan con todos los vehículos más modernos
- Sistema de apertura dual-side
- Disponible en 2 diferentes volúmenes de carga para las más extendidas necesidades de transporte
- Con 2 correas
- Conforme a la norma ISO/ PAS 11154:2006 Apartado 5.3.4./Directiva CEE 79/488
- Diseño patentado y sistema de bloqueo.

IT

- Realizzato in ABS di qualità con protezione ai raggi UV
- Box per chi desidera il top di gamma
- Per trasportare volumi importanti in modo confortevole
- Le linee eleganti ed esclusive si armonizzano con tutte le più moderne tipologie di auto.
- Sistema di apertura dual-side
- Disponibile in 2 differenti volumi di carico per le più diffuse esigenze di portaggio
- Con 2 cinghie per il fissaggio del carico
- Conforme alla norma ISO/PAS 11154:2006 Paragraph 5.3.4./Direttiva CEE 79/488
- Design e sistema di chiusura brevettati.

CUBO

360 - 460 - 500



Slim lock



DUAL-SIDE // ABS SLIMLOCK PREASSEMBLED // PREMONTADO // PREMONTATO

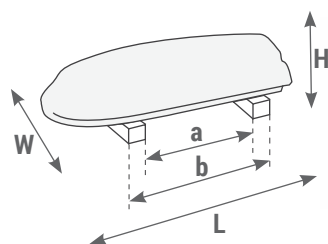

	Art. N°					L x W x H					Max Kg		a Min b Max
Cubo 360	12A80600		-	-	✓	cm 140x90x35	lt 360	Max 75x40 mm	Kg 14	Kg 75	1	Min 390 Max 800	
Cubo 460	12A81600		6	6	✓	cm 185x80x40	lt 460	Max 75x40 mm	Kg 17	Kg 75	1	Min 420 Max 1120	
	12A81900		6	6	✓	cm 185x80x40	lt 460	Max 75x40 mm	Kg 17	Kg 75	1		
	12A81800		6	6	✓	cm 185x80x40	lt 460	Max 75x40 mm	Kg 17	Kg 75	1		
Cubo 500	12A82100		7	7	✓	cm 202x89x38	lt 500	Max 75x40 mm	Kg 20	Kg 75	1	Min 470 Max 1180	

GB

- Made of high quality ABS with UV ray protection
- High quality box with unmistakable design
- The capacity and comfort of the loading surface guarantee a comfortable trip
- With dual-side opening system
- Available in 3 different capacities for more carrying requirements
- With 2 belts
- Corresponding to rule ISO/PAS 11154:2006 Paragraph 5.3.4./Directiva EEC 79/488
- Patented locking system.

ES

- Fabricado con ABS de calidad con protección frente a los rayos UV
- Box de calidad con un diseño inconfundible
- Su capacidad y su superficie de carga garantizan un cómodo viaje
- Sistema de apertura dual-side
- Disponible en 3 diferentes volúmenes de carga
- Con 2 correas
- Conforme a la norma ISO/ PAS 11154:2006 Apartado 5.3.4./Directiva CEE 79/488
- Sistema de cierre patentado

IT

- Realizzato in ABS di qualità con protezione ai raggi UV
- Box di qualità dal design inconfondibile
- La capacità ed il piano di carico garantiscono un viaggio comodo
- Sistema di apertura dual-side
- Disponibile in 3 differenti volumi di carico
- Con 2 cinghie per il fissaggio del carico
- Conforme alla norma ISO/PAS 11154:2006 Paragraph 5.3.4./Direttiva CEE 79/488
- Sistema di chiusura brevettato.

+ CITY CRASH TEST

+ 2 YEARS WARRANTY

+ PATENTED

HUSKI









SKI & BOARD

NEW!



IDEAL FOR // IDEAL PARA // IDEALE PER: CARVING · SNOWBOARD · TELEMARCK



	Art. N°						 LxHxP mm		
HUSKI Ski & Board	6940004	3	3	3	2	✓	510 x 210 x 310	6.5 Kg	1

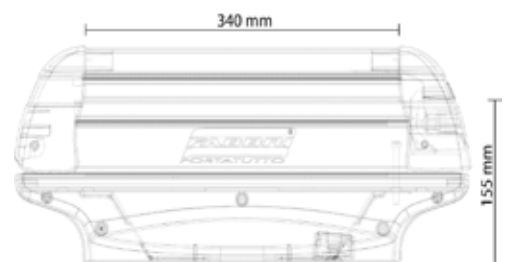



- **GB** • Universal magnetic ski & snowboard rack : it carries up to 3 pairs of skis or 2 snowboards
- With steel safety cord to secure the ski rack to the vehicle
- With lock
- Product disassembly through a release lever included
- Magnetic scratchproof plate
- Easy & fast assembly without the use of tools
- Aluminium
- Corresponding to rule DIN 75302

- **ES** • Universal magnetic ski & snowboard rack : it carries up to 3 pairs of skis or 2 snowboards
- With steel safety cord to secure the ski rack to the vehicle
- With lock
- Product disassembly through a release lever included
- Magnetic scratchproof plate
- Easy & fast assembly without the use of tools
- Aluminium
- Conforme a la Norma DIN 75302

- **IT** • Portasci magnetico universale per trasportare fino a 3 paia di sci o 2 snow-board.
- Con cavo di sicurezza in acciaio per assicurare il portasci al veicolo.
- Con chiusura antifurto.
- Smontaggio del prodotto tramite apposita leva di sgancio in dotazione.
- Piastra magnetica antigraffio
- Montaggio semplice e veloce senza l'utilizzo di utensili.
- Conforme alla Normativa DIN 75302

KOLUMBUS

SKI & BOARD



IDEAL FOR // IDEAL PARA// IDEALE PER: SKI & SNOWBOARD · TELEMARCK



	Art. N°									
Kolumbus Ski & Board GREY	6940002	1-2	1-3	1-2	1-2	✓	✓	✓	Kg 9	1
Kolumbus Ski & Board BLACK	6940003	1-2	1-3	1-2	1-2	✓	✓	✓	Kg 9	1

GB

- Magnetic antitheft ski and snowboard rack for 2 pairs of skis of any kind (even extreme Carving) or 2 snowboards or 1 pair of skis and 1 snowboard
- The elevated fitting and higher than the norm magnetic plates guarantee a safe transport of the skis/snowboards even under extreme situations.
- It doesn't damage the paint, due to a particular protection of the magnetic plates.
- With double patented antitheft – once locked, the skis and also the ski rack are antitheft.
- With a special rubber mixture protection, it creates a barrier against water infiltrations, which in case of freezing, could compromise the excellent fitting of the magnetic plate on the car roof
- Corresponding to rule ISO/PAS 11154:2006 Paragraph 5.3.4./Directive EEC 79/4888.

ES

- Portaesquíes/snowboard magnético antirrobo para 2 pares de esquís de cualquier tipo (incluso extrem Carving o de esquí de fondo) o 2 snowboards o 1 par de esquís de cualquier tipo y 1 snowboard
- Las placas magnéticas de elevado cierre y superiores a la norma garantizan el transporte seguro de los esquís/snowboards incluso en situaciones extremas
- No estropea el barniz gracias a la protección especial de las placas magnéticas
- Con doble antirrobo patentado - una vez cerrado lo convierte en antirrobo para los esquís y también para el portaesquí
- Con protección de mezcla especial de goma, crea una barrera contra las infiltraciones de agua que al congelarse podrían comprometer el óptimo cierre estanco de la placa magnética sobre el techo del coche
- Conforme a la norma ISO/ PAS 11154:2006 Apartado 5.3.4./Directiva CEE 79/4888

IT

- Portasci e porta snowboard magnetico per 2 paia di sci di qualsiasi tipo (anche extreme Carving o sci da fondo) oppure 2 Snowboard oppure 1 paio di sci di qualsiasi tipo e uno snowboard
- Le piastre magnetiche di elevata tenuta e superiori alla norma garantiscono il trasporto sicuro degli sci/snowboard anche in situazioni estreme
- Non rovina la vernice grazie alla protezione particolare delle piastre magnetiche
- Con doppio antifurto brevettato - una volta chiuso lo rende antifurto per gli sci e anche per il portasci
- Con protezione in speciale mescola di gomma, crea una barriera contro le infiltrazioni d'acqua che ghiacciando potrebbero compromettere l'ottimale tenuta della piastra magnetica sul tetto dell'auto
- Conforme alla norma ISO/PAS 11154:2006 Paragraph 5.3.4./Direttiva CEE 79/4888

KOLUMBUS DELUXE



IDEAL FOR // IDEAL PARA // IDEALE PER: EXTREME CARVING SKIS



	Art. N°									
Kolumbus Deluxe GREY	6960100	2	2	2	-	✓	✓	✓	Kg 6	1
Kolumbus Deluxe BLACK	6960101	2	2	2	-	✓	✓	✓	Kg 6	1

GB

- Magnetic antitheft ski rack for 2 pairs of skis of any kind, particularly suitable for all the extreme carving due to new ski fittings extremely elastic in a diagonal shape and with wide arm.
- The elevated fitting and higher than the norm magnetic plates guarantee a safe transport of the skis even under extreme situations
- It doesn't damage the paint, due to a particular protection of the magnetic plates
- With double patented antitheft – once locked, the skis and also the ski rack are antitheft
- With a special rubber mixture protection, it creates a barrier against water infiltrations, which in case of freezing, could compromise the excellent fitting of the magnetic plate on the car roof
- Corresponding to rule ISO/PAS 11154:2006 Paragraph 5.3.4./Directiva EEC 79/4888

ES

- Portaesquí magnético antirrobo para 2 pares de esquís de cualquier tipo, especialmente indicado para todos extrem carving gracias al nuevo paraesquí sumamente elástico en forma diagonal y al amplio brazo
- Las placas magnéticas de elevado cierre y superiores a la norma garantizan también el transporte seguro de los esquís en situaciones extremas
- No estropea el barniz gracias a la protección especial de las placas magnéticas
- Con doble antirrobo patentado - una vez cerrado lo convierte en antirrobo para los esquís y también para el portaesquí
- Con protección de mezcla especial de goma, crea una barrera contra las infiltraciones de agua que al congelarse podrían comprometer el óptimo cierre estanco de la placa magnética sobre el techo del coche
- Conforme a la norma ISO/ PAS 11154:2006 Apartado 5.3.4./Directiva CEE 79/4888

IT

- Portasci magnetico antifurto per 2 paia di sci di qualsiasi tipo, particolarmente adatto a tutti i tipi di sci carving grazie al nuovo fermasci estremamente elastico in forma diagonale e all' ampio braccio
- Le piastre magnetiche di elevata tenuta e superiori alla norma garantiscono il trasporto sicuro degli sci anche in situazioni estreme
- Non rovina la vernice grazie alla protezione particolare delle piastre magnetiche
- Con doppio antifurto brevettato - una volta chiuso lo rende antifurto per gli sci e anche per il portasci
- Con protezione in speciale miscela di gomma, crea una barriera contro le infiltrazioni d'acqua che ghiacciando potrebbero compromettere l'ottimale tenuta della piastra magnetica sul tetto dell'auto
- Conforme alla norma ISO/PAS 11154:2006 Paragraph 5.3.4./Direttiva CEE 79/4888







+ 2 YEARS WARRANTY

+ CITY CRASH TEST



IDEAL FOR // IDEAL PARA // IDEALE PER: CARVING SKIS



	Art. N°							
SKO	13A99700	2	2	2	✓	✓	Kg 3,8	1

GB

- Magnetic anti-theft ski rack for 2 pairs of skis of any kind, particularly suitable for all the extreme carving
- With anti-theft
- The elevated fitting and higher than the norm magnetic plates guarantee a safe transport of the skis even under extreme situations
- Particularly suitable for all extreme Carving due to the "diagonal" ski-fitting
- It doesn't damage the paint, due to a particular protection of the magnetic plates
- Corresponding to rule DIN 75302

ES

- Portaesquí magnético antirrobo para 2 pares de esquís de cualquier tipo
- Con antirrobo
- Las placas magnéticas de elevado cierre y superiores a la norma garantizan también el transporte seguro de los esquís en situaciones extremas
- Particularmente apto para todos los esquís de carving extremo gracias a su sistema de bloqueo "diagonal"
- No estropea el barniz gracias a la protección especial de las placas magnéticas
- Conforme a la Norma DIN 75302

IT

- Portasci magnetico antifurto per 2 paia di sci di qualsiasi tipo, particolarmente adatto a tutti i tipi di sci carving
- Le piastre magnetiche di elevata tenuta e superiori alla norma garantiscono il trasporto sicuro degli sci anche in situazioni estreme
- Particolarmente adatto per tutti i carving extreme grazie al fermasci "diagonale"
- Non rovina la vernice grazie alla protezione particolare delle piastre magnetiche
- Conforme alla Normativa DIN 75302

TACO

SKI & BOARD



IDEAL FOR // IDEAL PARA // IDEALE PER: CARVING · SNOWBOARD · TELEMARCK



	Art. N°								
TACO Ski & Board	13A95500	1 - 3	1 - 3	1 - 3	1 - 2	✓	✓	Kg 5,8	1

GB

- Magnetic antitheft ski and snowboard rack for up to 3 pairs of skis of any kind (even extreme Carving) or 2 snowboards
- With antitheft
- The elevated fitting and higher than the norm magnetic plates guarantee a safe transport of the skis/snowboards even under extreme situations
- The double magnetic plate enables application to particularly uneven roof.
- It doesn't damage the paint, due to a particular protection of the magnetic plates.
- Corresponding to rule ISO/PAS 11154:2006 Paragraph 5.3.4./Directive EEC 79/4888.

ES

- Portaesquí magnético de atractivo diseño con sistema antirrobo para 3 pares de esquís en todos los modelos (también carving) o 2 snowboards
- Las placas magnéticas de elevado cierre y superiores a la norma garantizan el transporte seguro de los esquís/snowboards incluso en situaciones extremas
- Con antirrobo
- La doble base magnética permite su montaje aún sobre techos particularmente curvados
- No estropea el barniz gracias a la protección especial de las placas magnéticas
- Conforme a la norma ISO/ PAS 11154:2006 Apartado 5.3.4./Directiva CEE 79/4888

IT

- Portasci e porta snowboard magnetico per trasportare fino a 3 paia di sci di tutti i tipi (anche carving) oppure 2 snowboard
- Con antifurto
- Le piastre magnetiche di elevata tenuta e superiori alla norma garantiscono il trasporto sicuro degli sci/snowboard anche in situazioni estreme
- La doppia base magnetica consente l'applicazione su tetti particolarmente tondeggianti
- Non rovina la vernice grazie alla protezione particolare delle piastre magnetiche
- Conforme alla norma ISO/PAS 11154:2006 Paragraph 5.3.4./Direttiva CEE 79/4888

+ 2 YEARS WARRANTY

+ CITY CRASH TEST

ELLISSE

SKI & BOARD



IDEAL FOR // IDEAL PARA // IDEALE PER: CARVING · SNOWBOARD · TELEMARCK



	Art. N°							
ELLISSE Ski & Board	6960810	2	2	2	1-2	✓	Kg 2,5	1

GB

- Magnetic ski rack for 2 pairs of skis of any kind (even extreme Carving, Telemark or cross-country skis) or 2 snowboards
- The elevated fitting and higher than the norm magnetic plates guarantee a safe transport of the skis/snowboards even under extreme situations
- It doesn't damage the paint, due to a particular protection of the magnetic plates
- Corresponding to rule ISO/PAS 11154:2006 Paragraph 5.3.4./Directive EEC 79/4888.

ES

- Portaesquí magnético para 2 pares de esquís de cualquier tipo (incluso extrem Carving, Telemark o de esquí de fondo) o 2 snowboards
- Las placas magnéticas de elevado cierre y superiores a la norma garantizan el transporte seguro de los esquís/snowboards incluso en situaciones extremas
- No estropea el barniz gracias a la protección especial de las placas magnéticas
- Conforme a la norma ISO/ PAS 11154:2006 Apartado 5.3.4./Directiva CEE 79/4888

IT







- Portasci magnetico per 2 paia di sci di qualsiasi tipo (anche carving estremi, telemark o sci da fondo) oppure 2 snowboard
- Le piastre magnetiche di elevata tenuta e superiori alla norma garantiscono il trasporto sicuro degli sci/snowboard anche in situazioni estreme
- Non rovina la vernice grazie alla protezione particolare delle piastre magnetiche
- Conforme alla norma ISO/PAS 11154:2006 Paragraph 5.3.4./Direttiva CEE 79/4888

ELLISSE



IDEAL FOR CROSS-COUNTRY SKI // IDEAL PARA ESQUI DE FONDO // IDEALE PER SCI DA FONDO



	Art. N°							
ELLISSE	6960800	2	1 - 2	2	-	✓	Kg 2,5	1

GB

- Magnetic ski rack for 2 pairs of skis
- With ski fitting blocks of extremely elastic material – particularly suitable for all cross-country skis
- The elevated fitting and higher than the norm magnetic plates guarantee a safe transport of the skis even under extreme situations
- It doesn't damage the paint, due to a particular protection of the magnetic plates.
- The minimum axle base between 2 ski fittings, of 36 cm only, makes it ideal for any kind of car, thus solving the transport problem on vehicles with reduced roof dimensions (Sports cars, Coupé)
- Corresponding to rule ISO/PAS 11154:2006 Paragraph 5.3.4./Directive EEC 79/4888.

ES

- Portaesquí magnético para 2 pares de esquís
- Con bloqueos paraesquí de material sumamente elástico - especialmente indicado para todos los esquís de fondo
- Las placas magnéticas de elevado cierre y superiores a la norma garantizan también el transporte seguro de los esquís en situaciones extremas
- No estropea el barniz gracias a la protección especial de las placas magnéticas
- El interje mínimo entre los 2 paraesquí, solamente de 36 cm, lo hace ideal para cualquier tipo coche, resolviendo así el problema del transporte sobre coches con el techo de tamaño reducido (coches deportivos, coupé)
- Conforme a la norma ISO/ PAS 11154:2006 Apartado 5.3.4./Directiva CEE 79/4888

IT

- Portasci magnetico per trasportare fino a 2 paia di sci
- Con blocchi fermasci in materiale estremamente elastico – particolarmente adatto per tutti gli sci da fondo.
- Le piastre magnetiche di elevata tenuta e superiori alla norma garantiscono il trasporto sicuro degli sci anche in situazioni estreme
- Non rovina la vernice grazie alla protezione particolare delle piastre magnetiche
- L'interasse minimo tra i 2 fermasci, soltanto di 36 cm, lo rende ideale per ogni tipo auto, risolvendo così il problema del trasporto su vetture con il tetto delle dimensioni ridotte (auto sportive, coupé)
- Conforme alla norma ISO/PAS 11154:2006 Paragraph 5.3.4./Direttiva CEE 79/4888

 2 YEARS WARRANTY

 CITY CRASH TEST

ALUSKI & BOARD UNIVERSALE

ALUMINIUM!



ULTRA RAPID MOUNTING // MONTAJE // MONTAGGIO

	Art. N°									
Aluski & Board 3	6801897	3	3	3	2	✓	Kg 2,2	30x20 mm	22x6.5 mm	1
Aluski & Board 4	6801896	4	4	4	2	✓	Kg 2,7	30x20 mm	22x6.5 mm	1



ADATTATORE	Art. N°			
Adattatore Aluski & Board Barre 60 mm	6801863	Kg 0,4	max 60x30 mm	1



OPTIONAL RIALZO ALUSKI	Art. N°			
Optional Rialzo	6801864	✓	✓	1

(Dettaglio / Detail Pg. 65)

GB

- Universal ski and snowboard racks to fit on all 30x20 mm section steel bars and on most aluminium bars with groove
- With steel safety hook
- Antitheft
- Optional accessory for ski and snowboard rack made of aluminium and ABS
- Particularly suitable for all extreme carving due to the "diagonal" ski-fitting
- Corresponding to rule ISO/PAS 11154:2006 Paragraph 5.3.4./Directive EEC 79/4888

ES

- Portaesquíes/snowboard universal que se puede montar en todas las barras de acero de sec. 30x20 y en la mayor parte de las barras de aluminio con canal
- Con gancho de seguridad de acero
- Con sistema antirrobo
- Portaesquíes/portasnowboard opcional de aluminio y ABS
- Especialmente adecuado para todos extrem carving gracias al paraesquíes "diagonal"
- Conforme a la norma ISO/ PAS 11154:2006 Apartado 5.3.4./Directiva CEE 79/488

IT

- Portasci e snowboard universale montabile su tutte le barre in acciaio sez. 30X20 e per la maggior parte delle barre in alluminio con canalina
- Con gancho di sicurezza in acciaio per bloccare gli sci anche quando il portasci non è chiuso con la chiave
- Antifurto
- Optional portasci/porta snowboard in alluminio e ABS.
- Particolarmente adatto a tutti i carving grazie ai fermasci "diagonale"
- Conforme alla norma ISO/ PAS 11154:2006 Paragraph 5.3.4./Direttiva CEE 79/488

ALUSKI & BOARD

NEW

ALUMINIUM!



RAISED // ELEVADO // RIALZATO



	Art. N°								
Aluski & Board New 3	6801899	3	3	3	2	✓	Kg 2,2	22x6.5 mm	1
Aluski & Board New 4	6801898	4	4	4	2	✓	Kg 2,7	22x6.5 mm	1

ADATTATORE	Art. N°			
Adattatore Aluski & Board Barre 60 mm	6801863	Kg 0,4	max 60x30 mm	1

OPTIONAL RIALZO ALUSKI	Art. N°			
Optional Rialzo	6801864	✓	✓	1

(Dettaglio / Detail Pg. 65)

GB

- Universal ski and snowboard racks for aluminium bars with groove
- With steel safety hook
- Antitheft
- Optional ski rack/snowboard rack in aluminium and ABS
- Particularly suitable for all extreme carving due to the "diagonal" ski-fitting
- Corresponding to rule DIN 75302

ES

- Estante universal de esquí y snowboard para barras de aluminio con canal
- Con gancho de seguridad de acero
- Con sistema antirrobo
- Portaesquíes/portasnowboard opcional de aluminio y ABS
- Especialmente adecuado para todos extrem carving gracias al paraesquí "diagonal"
- Conforme a la Norma DIN 75302

IT

- Portasci e snowboard universale per barre in alluminio con canalina
- Con gancho di sicurezza in acciaio per bloccare gli sci anche quando il portasci non è chiuso con la chiave
- Antifurto
- Optional portasci/porta snowboard in alluminio e ABS.
- Particolarmente adatto a tutti i carving grazie al fermasci "diagonale"
- Conforme alla Normativa DIN 75302

+ 2 YEARS WARRANTY

ALUSKI

3-4-5-6-8

ALUMINIUM!



ULTRA RAPID MOUNTING // MONTAJE // MONTAGGIO

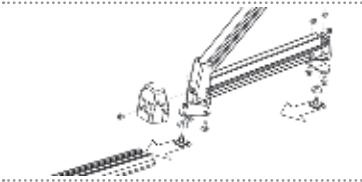

	Art. N°									
Aluski 3	6801880	3	3	3	2	✓	Max 40x40 mm	Kg 1,5	1	
Aluski 4	6801882	4	4	4	2	✓	Max 40x40 mm	Kg 1,6	1	
Aluski 5	6801884	5	5	5	2	✓	Max 40x40 mm	Kg 1,8	1	
Aluski 6	6801886	6	6	6	4	✓	Max 40x40 mm	Kg 2,1	1	
Aluski 8	6801888	8	8	8	4	✓	Max 40x40 mm	Kg 2,6	1	

ADATTATORE BARRE 60 mm	Art. N°			
Adattatore Aluski Barre 60 mm	6229703	Kg 0,4	max 60x40 mm	1

ADATTATORE A BINARIO	Art. N°			
Adattatore Aluski Barre a binario	6229702	Kg 0,55	22x6.5 mm	1

OPTIONAL RIALZO ALUSKI	Art. N°			
Optional Rialzo	6801864	✓	✓	1

(Dettaglio / Detail Pg. 65)

GB

- Optional accessory for ski and snowboard for all bars with a maximum section of 40x40 mm
- With steel safety hook
- Antitheft
- Aluminium, ABS and galvanized painted steel
- Corresponding to rule ISO/PAS 11154:2006 Paragraph 5.3.4./Directive EEC 79/4888

ES

- Portaesquí universal para todas las barras de hasta una sección max. 40 x 40 mm
- Con gancho de seguridad de acero
- Con sistema antirrobo
- Aluminio, ABS, acero cincado y barnizado
- Conforme a la norma ISO/ PAS 11154:2006 Apartado 5.3.4./Directiva CEE 79/488

IT

- Optional portasci e snowboard per tutte le barre fino a sezione max. 40 x 40 mm
- Con gancho di sicurezza in acciaio per bloccare gli sci anche quando il portasci non è chiuso con la chiave
- In alluminio, ABS, acciaio zincato e verniciato
- Antifurto
- Conforme alla norma ISO/PAS 11154:Paragraph 5.3.4./Direttiva CEE 79/488

OPTIONAL RIALZO

ALUSKI



	Art. N°			
Optional Rialzo per Aluski ed Aluski & Board	6801864	✓	✓	1



ALUSKI con BARRE 30X20

L30 X H20



ALUSKI con BARRE VIVA 2

L42 X H30



ALUSKI con BARRE TOP ROAD

A BINARIO



ALUSKI & BOARD con BARRE TOP ROAD

A BINARIO



- GB**
- Spacer flange for ski carrier Aluski 3-4-5-6-8 and Aluski & Board
 - It allows to raise the ski carrier by 40 mm
 - For fitting on bars with L30-42 x H20-35 mm section or on rail bars

- ES**
- Espaciador de alza para portaesquíes Aluski 3-4-5-6-8 y Aluski & Board
 - Permite de levantar el portaesquíes de 40 mm
 - Para el montaje sobre barras que tienen sección L30-42 x H20-35 mm o sobre barras a vía

- IT**
- Distanziale di rialzo per portasci Aluski 3-4-5-6-8 ed Aluski & Board
 - Permette di rialzare il portasci di 40 mm
 - Per il montaggio su barre con sezione L30-42 x H20-35 mm o su barre a binario

+ 2 YEARS WARRANTY



SICUR

2-3-5

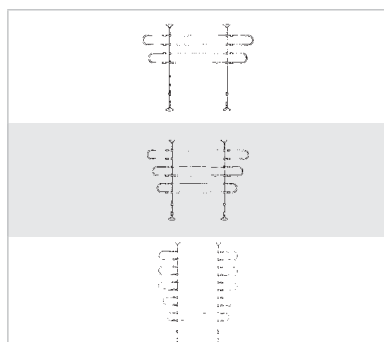

UNIVERSAL AND ROBUST // UNIVERSAL Y ROBUSTO // UNIVERSALI E ROBUSTE



	Art. N°			
Sicur 2	6151260	cm 88-147 x 65-110	Kg 3,60	1
Sicur 3	6151261	cm 88-147 x 84-129	Kg 4,85	1
Sicur 5	6151262	cm 88-147 x 110-155	Kg 7,00	1

GB

- Dog separator
- Universal for any kind of vehicles (cars, volume cars and station-wagon)
- The telescopic height and width adjustment system allows an easy and proper application on most vehicles
- Pre-assembled.
- Constructed in lacquered galvanized steel tubing.

ES

- Rejillas para perros
- Universal para todos los tipos de vehículo (coches, monovolúmenes y station wagon)
- El sistema de regulación telescópico en altura y anchura permite una fácil y adecuada colocación en el mayor número de vehículos
- Completamente montadas
- Fabricadas en tubular de acero cincado y barnizado

IT

- Griglie, per il trasporto di cani, che separano l'abitacolo della vettura dal bagagliaio
- Adattabili a tutti i tipi di veicolo (berline, monovolume e station wagon)
- Il sistema di regolazione telescópico in altezza e larghezza consente una facile e adeguata applicazione
- Completamente montate
- Costruite in tubolare di acciaio zincato e verniciato con protezioni per il trasporto degli animali

PANNELLI PER CARICHI SPORGENTI OMOLOGATI TIPO ITALIANO E TIPO SPAGNOLO
SENAES CARGA SALIENTE HOMOLOGADOS TIPO ITALIANO Y TIPO ESPANOL
ITALIAN AND SPANISH HOMOLOGATED REAR REFLECTING PANELS FOR PROTRUDING LOADS

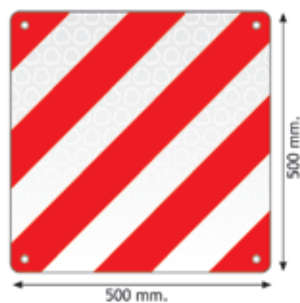

Tipo italiano / Italian type



Tipo spagnolo / Spanish type

Cod. Code	Tipo Type	Materiale Material	mm	Confezione Embalaje Pack
90079	italiano/ italian	alluminio/aluminio/aluminium	500x500x1	10
90068	spagnolo/español/ spanish	alluminio/aluminio/aluminium	500x500x1,4	10

PANNELLI PER CARICHI SPORGENTI TIPO BENELUX
SENAES CARGA SALIENTE TIPO BENELUX
REAR REFLECTING PANELS FOR PROTRUDING LOADS (BENELUX COUNTRIES)

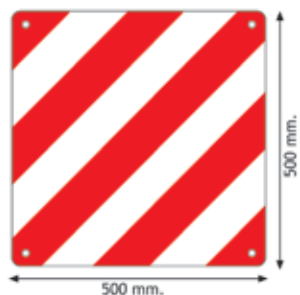

Cod. 90034

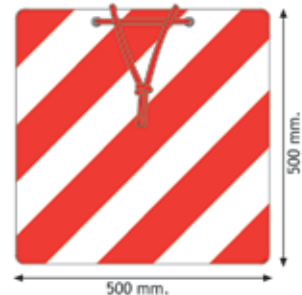

Cod. 90065

Cod.90034: Con angoli arrotondati e con 4 fori rivettati
 Cod.90034: Con ángulos redondeados y con 4 ojales remachados
 Cod.90034: Panel with 4 riveted holes and rounded corners

Cod.90065: Con 2 fori rivettati e corda
 Cod.90065: Con 2 ojales remachados y cuerda
 Cod.90065: Panel with 2 riveted holes and rope

Cod. Code	Classe pellicola Clase película Film Class	Materiale Material	mm	Confezione Embalaje Pack
90034	CL1	alluminio/aluminio/aluminium	500x500x1	10
90065	CL1	alluminio/aluminio/aluminium	500x500x1	7

GB

- Homologated Italian, Spanish and Benelux panels for protruding loads
- The Italian ministerial decree n.12222 of 18/04/1995 obliges to use the panel on an alu support with relevant homologation. The panel should be put at the rear end of the protruding load and, thanks to the riveted holes, can be mounted in any case
- The use of the panel on an alu support with relevant homologation (regulation V.20 on film CL.2) is mandatory in Spain following the Spanish law. It must be put at the rear end of the protruding loads (as to Royal Decree 2822/1998 of 23/12/1998)
- The use of the panel on an alu support of 1 mm with film CL.1 is mandatory in Benelux following the Belgian and Dutch law

ES

- Señales para la carga saliente homologados tipo italiano, tipo español y tipo Benelux
- En Italia, según el Decreto Ministerial n.1222 del 18-04-1995 que obliga el uso del señal sobre soporte de aluminio con homologación correspondiente
El señal tiene que ser colocado a la extremidad trasera de la carga saliente y gracias a los ojales remachados la aplicación es posible en todos los casos
- En España, en base a la legislación española, el uso del señal es obligatorio sobre el soporte de aluminio con la homologación española correspondiente, reglamento V.20 en película cl.2 y tiene que ser colocado a la extremidad trasera de la carga saliente. Según Decreto Real 2822/1998 del 23/12/1998
- En Benelux, según la legislación belga y holandesa, el uso del señal es obligatorio sobre soporte de aluminio de 1 mm y película cl.1 en diferentes variaciones

IT

- Pannelli per carichi sporgenti omologati tipo italiano, tipo spagnolo e tipo Benelux
- In Italia in base al Decreto Ministeriale n. 1222 del 18-04-1995 che obbliga l'uso del pannello su supporto di alluminio con relativa omologazione. Il pannello deve essere posto all'estremità posteriore del carico sporgente e, grazie ai fori rivettati è possibile l'applicazione in tutti i casi possibili.
- In Spagna in base alla legislazione spagnola è obbligatorio l'uso del pannello su supporto di alluminio con relativa omologazione spagnola regolamento V.20 in pellicola cl. 2 e deve essere posto all'estremità del carico sporgente. Come da Reale Decreto 2822/1998 del 23/12/1998.
- In Benelux in base alla legislazione belga e olandese è obbligatorio l'uso del pannello su supporto di alluminio da 1 mm su pellicola in Classe 1 nelle varie variazioni.

UNISPIDER



STAINLESS POLISHED STEEL // ACERO INOX PULIDO // ACCIAIO INOX LUCIDATO

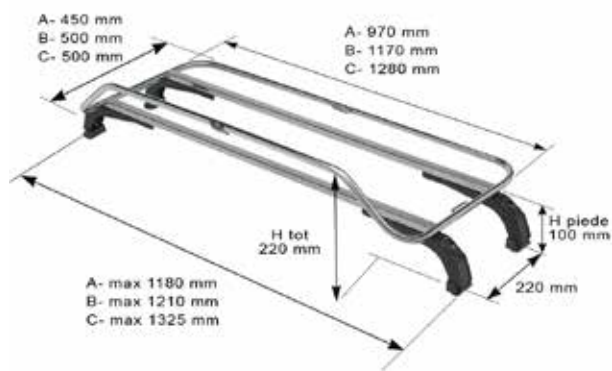

	Art. N°			
Unispider A	11A20100	cm 97x45	Kg 4,5	1
Unispider B	11A22000	cm 117x50	Kg 5,2	1
Unispider C	11A23000	cm 128x50	Kg 6	1

GB

- Rear luggage-racks for sports cars and convertibles
- With adjustable feet in width
- Made of stainless polished steel
- It enables the safe and comfortable transport of luggage that won't fit into the boot.
- Available in three versions.

ES

- Portaequipaje posterior para vehículos descapotables y coupé
- Con pies ajustables en ancho
- Fabricado en acero inoxidable pulido
- Permite el transporte cómodo y seguro de las maletas que no caben en el maletero del coche
- Disponible en tres dimensiones

IT









- Portabagagli posteriore per vetture spider e coupé
- Con piedi regolabili in larghezza
- Realizzato in acciaio inox lucidato
- Permette di trasportare in sicurezza le valigie che non trovano posto nel vano bagagli
- Disponibile in tre dimensioni

OPTIONAL SKI & BOARD UNISPIDER



IDEAL FOR // IDEAL PARA // PER: EXTREME CARVING SKIS · SNOWBOARD



	Art. N°								
Optional Ski & Board Unispider	6801910	3	3	3	1-2	✓	✓	Kg 4	1

GB

- Optional ski rack to transform the rear luggage racks into ski- and snowboardrack
- To transport 3 paires of skis or 2 snowboards
- Particularly suitable for all extreme carving skis due to the "diagonal" ski-fitting
- Antitheft

ES

- Opcional para convertir el portaequipaje posterior en un portaesquí/snowboard
- Transporta 3 pares de esquís o 2 snowboards
- Particularmente apto para todos los esquís gracias a su sistema de bloqueo de esquís "diagonal"
- Con sistema antirrobo

IT

- Optional per trasformare il portabagagli posteriore in portasci/snowboard
- Per trasportare 3 paia di sci oppure 2 snowboards
- Particolarmente adatto per tutti i tipi di sci grazie al fermasci "diagonale"
- Antifurto

+ 2 YEARS WARRANTY





Un Italiano Vero!



PORTATUTTO

For Light Commercial Vehicles
Para Los Vehículos Comerciales
Per Veicoli Commerciali



GB

ES

IT

BARRO SYSTEM

ALUMINIUM!



GB

- Carrying system made on purpose for commercial vehicles.
- Available in two different kind of bars, in steel or in alu to respond to professionals' needs.
- Load 50 kg each bar
- Corresponding to rule DIN 75302

ES

- Solución de carga específicamente realizada para los vehículos comerciales.
- Barras disponibles en acero o en aluminio, según las exigencias de los clientes profesionales.
- Carga 50 kg por barra
- Conforme a la Norma DIN 75302

IT

- E' il sistema di portaggio appositamente realizzato per i veicoli commerciali.
- Due versioni di barre, in acciaio e in alluminio, per rispondere alle esigenze dei professionisti.
- Portata Kg 50 per singola barra.
- Conforme alla Normativa DIN 75302

BARRO

BARRO ALU



	Art. N°	↔	↻	📦	👤
BARRO cm 115	12A11500	115 cm	32x38 mm	1	Kg 1,8
BARRO cm 135	12A13500	135 cm	32x38 mm	1	Kg 2,1
BARRO cm 150	12A15000	150 cm	32x38 mm	1	Kg 2,4
BARRO cm 180	12A18000	180 cm	32x38 mm	1	Kg 2,9

	Art. N°	↔	↻	📦	👤
BARRO ALU cm 135	12A13600	135 cm	32x38 mm	1	Kg 1,6
BARRO ALU cm 150	12A15100	150 cm	32x38 mm	1	Kg 1,8
BARRO ALU cm 180	12A18100	180 cm	32x38 mm	1	Kg 2,2

GB

- Barro: the structure is made of anodized steel with reinforced section, covered with a black non-toxic sheath made of PVC.
- Barro Alu: the structure is made of anodized aluminium with reinforced section. The section has a sliding groove to let the optional be mounted in. Supplied with black PVC profile to support the transported load.

ES

- Barro: estructura en acero electro cincado con sección reforzada y con vaina de revestimiento de pvc negro anti-choque.
- Barro Alu: estructura en aluminio anodizado con sección reforzada con perfil de pvc negro fácilmente extraíble e insertable para el montaje de varios accesorios. En la canal y para un apoyo perfecto de la carga transportada.

IT

- Barro: struttura in acciaio elettrozincato a sezione rinforzata, rivestita da guaina in pvc nero antiurto.
- Barro alu: struttura in alluminio anodizzato e sezione rinforzata dotata di una canalina di scorrimento predisposta per l'inserimento degli accessori. Equipaggiata con profilo in pvc nero per appoggio carico trasportato.

+ 2 YEARS WARRANTY

KIT BARRO



	Art. N°			
Kit Fix Barro	174XXXXX	✓	Kg 2,7	1

Consultar tabla de aplicaciones en www.fabbri.info
 See application list on www.fabbri.info
 Consultare tabella applicazioni sul sito
www.fabbri.info

GB

• Kit Barro: fixing set for bars specific for each vehicle's model. Made of high-resistant techno polymer, easy to be mounted and supplied with antitheft locking closing.

ES

• Kit Barro: juego de fijación para barras, específico para cada vehículo. En tecnopolímero de elevada resistencia, fácil de instalar, patas con sistema antirrobo.

IT

• Kit Barro: sistema di ancoraggio barre specifico per ogni singolo modello di veicolo. In materiale tecnopolimero ad alta resistenza, facile da installare e dotato di sportello con serratura antifurto.

OPTIONALS BARRO SYSTEM



	Art. N°	↔	👤	📦
Loading roller Rodillo de carga Rullo da carico	16203000	68 cm	Kg 2,5	1

GB

- Loading roller for bars, the frame is made of steel, covered with shock-proof black PVC. It can be used in two positions (load/download and transport) for a complete comfort. It can be mounted on Barro and Alu Barro bars.

ES

- Rodillo de carga para barras transversales, estructura en metal, revestido con pvc atóxico negro anti-choque. Ajustable en dos posiciones (carga/descarga y transporte) para garantizar una total comodidad de uso. Se puede montar en todas las Barro barras de acero y alu.

IT

- Rullo da carico per barre portatutto, struttura in metallo, rivestito in pvc nero antiurto. Dotato di due posizioni (carico/scarico e trasporto) per un completo comfort di utilizzo. Applicabile a Barro e Barro Alu.



	Art. N°	👤	📦
Load blocking accessories Accesorios de bloqueo de carga Accessori fermacarico	11889400	Kg 1,47	4

GB

- Load blocking accessories to transport bulky goods, the fastening system means that it can slide along the whole length of the bars, adapting to suit various dimensions. It can be mounted on steel bars with sections 35x30 / 35x32 mm.

ES



- Accesorios de bloqueo de carga para el transporte de mercancía voluminosa, su sistema de montaje le permite deslizarse por sobre todo el largo de las barras adaptándose a las disintas dimensiones. Se puede montar en las barras de sec. 35x30/35x32mm.

IT

- Accessori fermacarico per il trasporto di merce ingombrante, il sistema di fissaggio gli permette di scorrere su tutta la lunghezza delle barre adattandosi a diverse dimensioni. Applicabili a barre con sezione 35x30 / 35x32 mm.

+ 2 YEARS WARRANTY



	Art. N°		
Ladder Escalera Scaletta	6801819	Kg 7,2	1

GB

• Pull-out ladder made of painted steel, in grey metalized colour, it can be folded, supplied with supports made of scratch resistant rubber.

ES

• Escalera móvil en acero barnizado con polvo de color gris metalizado, plegable, con apoyos en goma antiarañazos.

IT

• Scaletta mobile in acciaio verniciato a polvere di colore grigio metallizzato, ripieghevole, dotata di appoggi in gomma antigraffio.

ALU CARGO



GB

- Alu Cargo: luggage carrier the loading platform on the chassis is made with steel black bars, the sides are made of anodized aluminium. End caps made of thermoplastic material.
- Load : Kg.100-200 (1)
- Corresponding to rule DIN 75302

- (1) 4 fixing points Kg.100;
- (1) 6 fixing points Kg.150;
- (1) 8 fixing points Kg.200;

ES

- Alu Cargo: cuerpo portaequipaje con llano de carga en chasis de barras de acero color negro, con adrales de aluminio anodizado. Tapones terminales en material termoplástico.
- Carga: 100-200 Kg (1)
- Conforme a la Norma DIN 75302

- (1) 4 apoyos Kg.100;
- (1) 6 apoyos Kg.150;
- (1) 8 apoyos Kg.200;

IT

- Alu Cargo: portabagagli con piano di carico su telaio a barre in acciaio di colore nero, sponde in alluminio anodizzato. Tappi terminali in materiale termoplastico.
- Portata Kg 100 - 200 (1)
- Conforme alla Normativa DIN 75302

- (1) 4 Appoggi Kg.100;
- (1) 6 Appoggi Kg.150;
- (1) 8 Appoggi Kg.200;

+ 2 YEARS WARRANTY

ALU CARGO

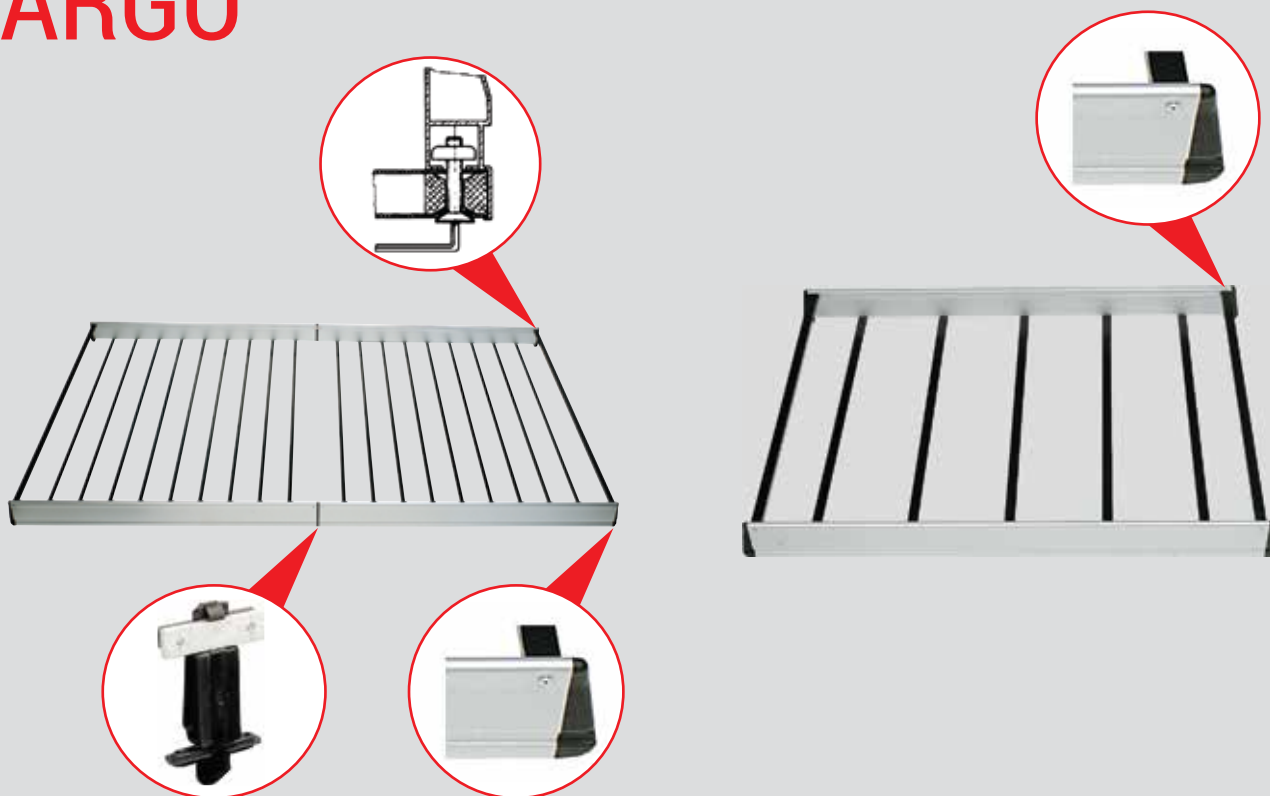

	Art. N°	ALU		
ALU CARGO 280x110	6401.405	✓	30x20 mm	Kg 27
ALU CARGO 280x130	6401.408	✓	30x20 mm	Kg 27,8
ALU CARGO 280x145	6401.411	✓	30x20 mm	Kg 28,8
ALU CARGO 280x180	6401.414	✓	30x20 mm	Kg 30,5
ALU CARGO 340x110	6401.417	✓	30x20 mm	Kg 32
ALU CARGO 340x130	6401.420	✓	30x20 mm	Kg 32,8
ALU CARGO 340x145	6401.423	✓	30x20 mm	Kg 33,5
ALU CARGO 340x180	6401.426	✓	30x20 mm	Kg 34,2
ALU CARGO 380x130	6401.429	✓	30x20 mm	Kg 36
ALU CARGO 380x145	6401.432	✓	30x20 mm	Kg 36,8
ALU CARGO 380x180	6401.435	✓	30x20 mm	Kg 38

	Art. N°	ALU		
ALU CARGO 140x110	6401.444	✓	30x20 mm	Kg 14
ALU CARGO 140x130	6401.447	✓	30x20 mm	Kg 15
ALU CARGO 170x110	6401.450	✓	30x20 mm	Kg 16
ALU CARGO 170x130	6401.453	✓	30x20 mm	Kg 16,5
ALU CARGO 170x145	6401.456	✓	30x20 mm	Kg 17
ALU CARGO 190x110	6401.459	✓	30x20 mm	Kg 18
ALU CARGO 190x130	6401.462	✓	30x20 mm	Kg 19
ALU CARGO 190x145	6401.465	✓	30x20 mm	Kg 20
ALU CARGO 240x145	6401.468	✓	30x20 mm	Kg 22

GB

• Alu Cargo: luggage carrier, available in many measures to cover the whole range of commercial vehicles.

ES



• Alu Cargo: cuerpos portaequipajes en diferentes medidas para cubrir toda la gama de vehículos comerciales.

IT

• Alu Cargo: portabagagli, con diverse misure per abbracciare l'intera gamma di veicoli commerciali.

KIT ALU CARGO



	Art. N°			
Kit Fix Alu Cargo	175XXXXX	-	Kg 2,7	1

Consultar tabla de aplicaciones en www.fabbri.info
 See application list on www.fabbri.info
 Consultare tabella applicazioni sul sito
www.fabbri.info

GB

• Kit Alu Cargo: fixing set for luggage carrier, it is specific for each model. Made of high-resistant techno polymer material, easy to be mounted.

ES

• Kit Alu Cargo: juego de fijación para cuerpos portaequipajes, específico para cada vehículo. En tecnopolímero de elevada resistencia, fácil de instalar.



IT

• Kit Alu Cargo: sistema di ancoraggio portabagagli specifico per ogni singolo modello di veicolo. In materiale tecnopolimero ad alta resistenza, facile da installare.

+ 2 YEARS WARRANTY

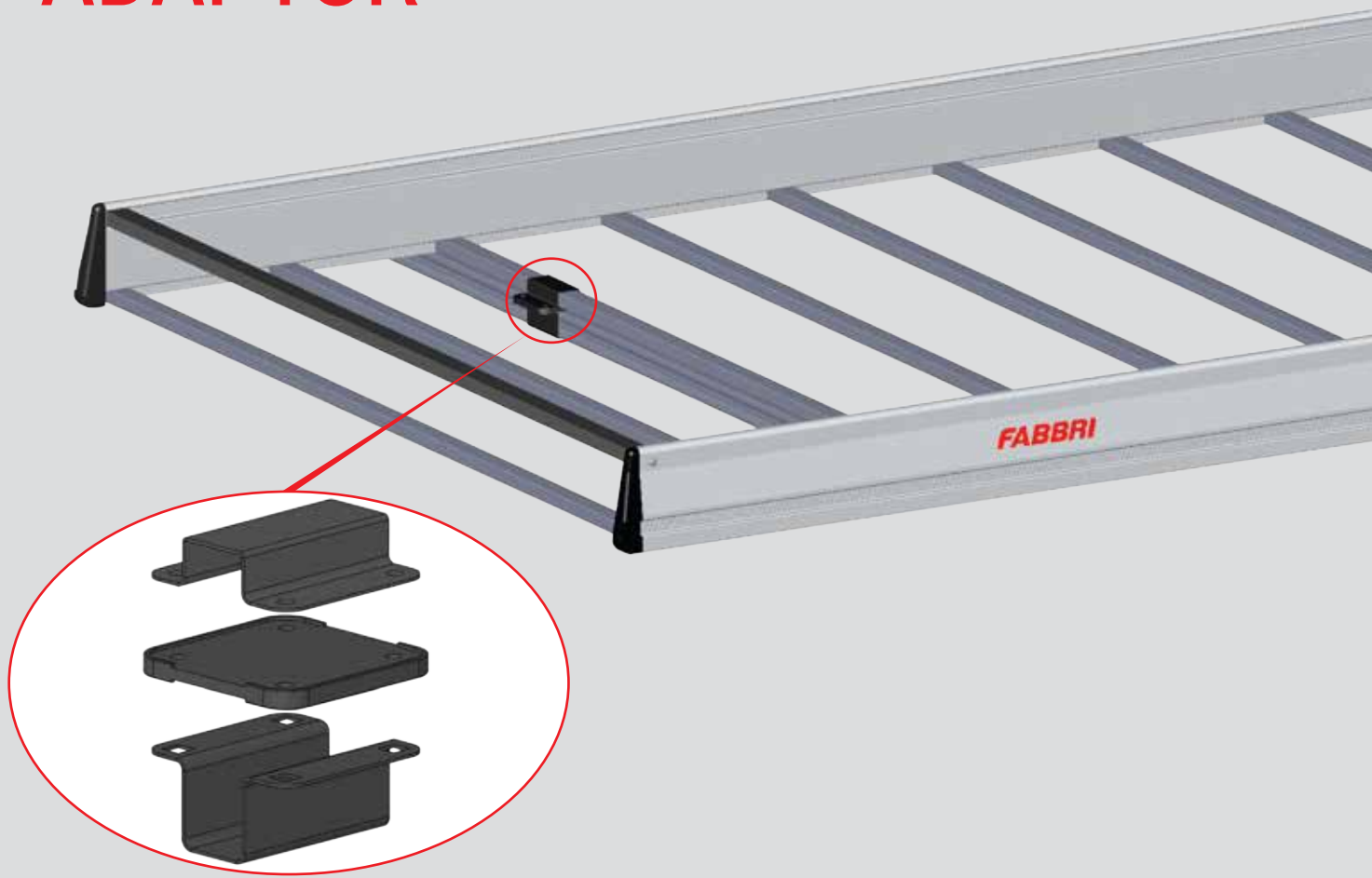
ALU CARGO ADAPTOR



	Art. N°			
Alu Cargo Adaptor	6801821	—	Kg 2	1

GB

• Alu Cargo Adaptor: Fixing set that allows to all Fabbri luggage-racks to be mounted on all Barro bars.

ES



• Alu Cargo Adaptor: sistema de anclaje que permite de montar todas las cestas portaequipajes Fabbri directamente sobre las barras de la gama «Barro System».

IT

• Alu Cargo Adaptor: E' il sistema di ancoraggio che adatta tutta la linea portabagagli Fabbri direttamente sulle barre portatutto della linea «Barro System».

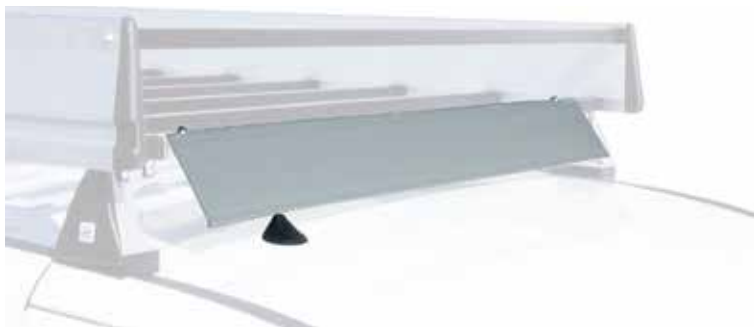
OPTIONALS ALU CARGO SYSTEM



	Art. N°		
Spoiler	6801818	Kg 2	1

GB

- Spoiler for luggage racks.



ES

- Spoiler para baca portaequipaje.

IT

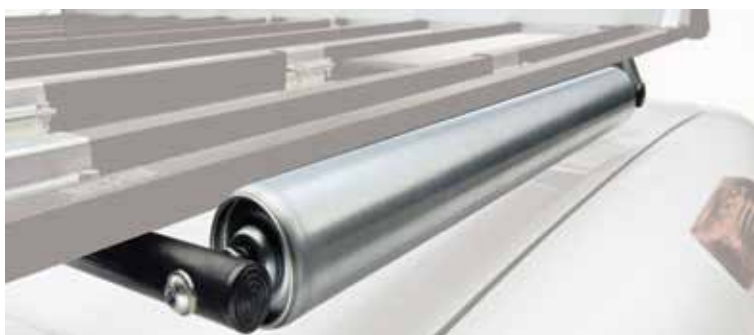
- Spoiler per portabagagli.



	Art. N°			
Loading roller Rodillo de carga Rullo da carico	6801816	60 cm	Kg 6,8	1

GB

- Loading roller for luggage racks.



ES

- Rodillo de carga para baca portaequipaje.

IT

- Rullo da carico per portabagagli.



	Art. N°		
Deluxe Ladder Escalera Deluxe Scala Deluxe	6801820	Kg 8	1

GB

- Universal extractable ladder made of aluminium for luggage racks. Supplied with 4 fixing points for an easy mounting under the luggage racks.

ES

- Escalera de aluminio universal extraíble para cestas portaequipajes. Incluidos 4 puntos de anclaje para un práctico montaje debajo de la cesta.

IT

- Scala in alluminio universale estraibile per ceste portabagagli. Inclusi 4 punti di ancoraggio per un pratico montaggio sotto la cesta.

+ 2 YEARS WARRANTY



	Art. N°		
Load blocking accessories Accesorios de bloqueo de carga Accessori fermacarico	6801814	Kg 0,6	2

GB

- Load blocking accessories to transport bulky goods. The fastening system means that it can slide along the whole length of the bars, adapting to suit various dimensions. It can be mounted on Barro bars (in steel or in aluminium).



ES

- Accesorios de bloqueo de carga para el transporte de mercancía voluminosa. Su sistema de montaje le permite deslizarse por sobre todo el largo de las barras adaptándose a las distintas dimensiones. Se puede montar en todas las Barro barras (de acero y alu).

IT

- Accessori fermacarico per il trasporto di merce ingombrante. Il sistema di fissaggio gli permette di scorrere su tutta la lunghezza delle barre adattandosi a diverse dimensioni. Applicabili a barre Barro (in acciaio e in alluminio).



	Art. N°		
Ladder lock Sujeta escaleras Fermascale	6801404	Kg 2	1

GB

- Optional ladder lock with balancing striker for luggage rack with transom cross-section 30x20 mm.

ES

- Sujeta escaleras opcional con encaje basculante para portaequipajes con travesaños de 30x20mm de sección.

IT

- Optional fermascale con riscontro basculante per portabagagli con traverse sezione 30x20 mm.

ALU MAXI GRONDINO

ALUMINIUM!



	Art. N°				22x6,5 mm 		
Alu Maxi Grondino	6203472	—	120 cm	✓	mm 40x35	Kg 6	1
	6203474	—	140 cm	✓	mm 40x35	Kg 6,7	1
	6203476	—	160 cm	✓	mm 40x35	Kg 7,3	1
	6203478	—	180 cm	✓	mm 40x35	Kg 7,9	1

GB

- The system made for vehicles with rain-gutters.
- The kit is composed of 2 complete bars made of tough aluminium with groove to mount optional.
- Corresponding to rule DIN 75302

ES

- Sistema de fijación para vehículos con vierteaguas.
- Kit compuesto de 2 barras completas de aluminio robusto con canaleta para el montaje de los accesorios.
- Conforme a la Norma DIN 75302

IT

- E' il sistema realizzato per veicoli muniti di grondino.
- Kit composto da 2 barre complete in robusto alluminio dotate di canaline per il montaggio degli accessori.
- Conforme alla Normativa DIN 75302

+ 2 YEARS WARRANTY

MAXI GRONDINO



	Art. N°						
Maxi Grondino	6203480	–	120 cm	✓	mm 30x20	Kg 6	1
	6203481	–	140 cm	✓	mm 30x20	Kg 6,7	1
	6203482	–	160 cm	✓	mm 30x20	Kg 7,3	1
	6203483	–	180 cm	✓	mm 30x20	Kg 7,9	1



OPTIONAL ADAPTOR

	Art. N°			
Alu Cargo Adaptor per barre 30x20	6801826	–	Kg 2	1

GB

- The system made for vehicles with rain-gutters.
- The kit is composed of 2 complete bars made of painted steel.
- Corresponding to rule DIN 75302

ES



- Sistema de fijación para vehículos con vierteaguas.
- Kit compuesto de 2 barras completas de acero lacado.
- Conforme a la Norma DIN 75302



IT



- E' il sistema realizzato per veicoli muniti di grondino.
- Kit composto da 2 barre complete in acciaio verniciato.
- Conforme alla Normativa DIN 75302



MODUL KIT GRONDINO

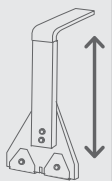

	Art. N°	x4	
	6401532	✓	1

	Art. N°	x6	
	6401534	✓	1

	Art. N°	x4	 x4		
	Extension 24/26	6201651	✓	Kg 0,5	1
	Extension 32/34	6201653	✓	Kg 1,0	1
	Extension 42/44	6201655	✓	Kg 1,5	1
	Extension 49/51	6201657	✓	Kg 1,9	1
	Extension 58/60	6201659	✓	Kg 2,4	1

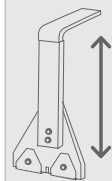
	Art. N°	x6	 x6		
	Extension 24/26	6401600	✓	Kg 1	1
	Extension 32/34	6401603	✓	Kg 1,6	1
	Extension 42/44	6401606	✓	Kg 2,3	1
	Extension 49/51	6401609	✓	Kg 2,9	1
	Extension 58/60	6401612	✓	Kg 3,6	1

GB

• Fixing set for luggage-racks made on purpose for vehicles with rain-gutters.

ES

• Sistema de anclaje para cestas portaequipajes específico para vehículos con vierteaguas.

IT

• Sistema di ancoraggio delle ceste portabagagli specifico per veicoli muniti di grondino.

+ 2 YEARS WARRANTY

FABBRI PORTATUTTO srl

Sede operativa: Via Guglielmo Marconi, n° 2 - I - 47832 Casarola - San Clemente (RN)





FABBRI PORTATUTTO srl

Sede operativa: Via Guglielmo Marconi, n° 2 - I - 47832 Casarola - San Clemente (RN)
Tel. +39 0541 988144 - Fax +39 0541 857318 - www.fabbri.info - info@fabbri.info

